

HEAT-TIMER®

INSTALLATION AND OPERATION INSTRUCTIONS

MPCQ Platinum

STEAM HEATING AND SEQUENCING CONTROL

RESET CONTROLS FOR MULTIPLE BOILER STEAM HEATING SYSTEMS

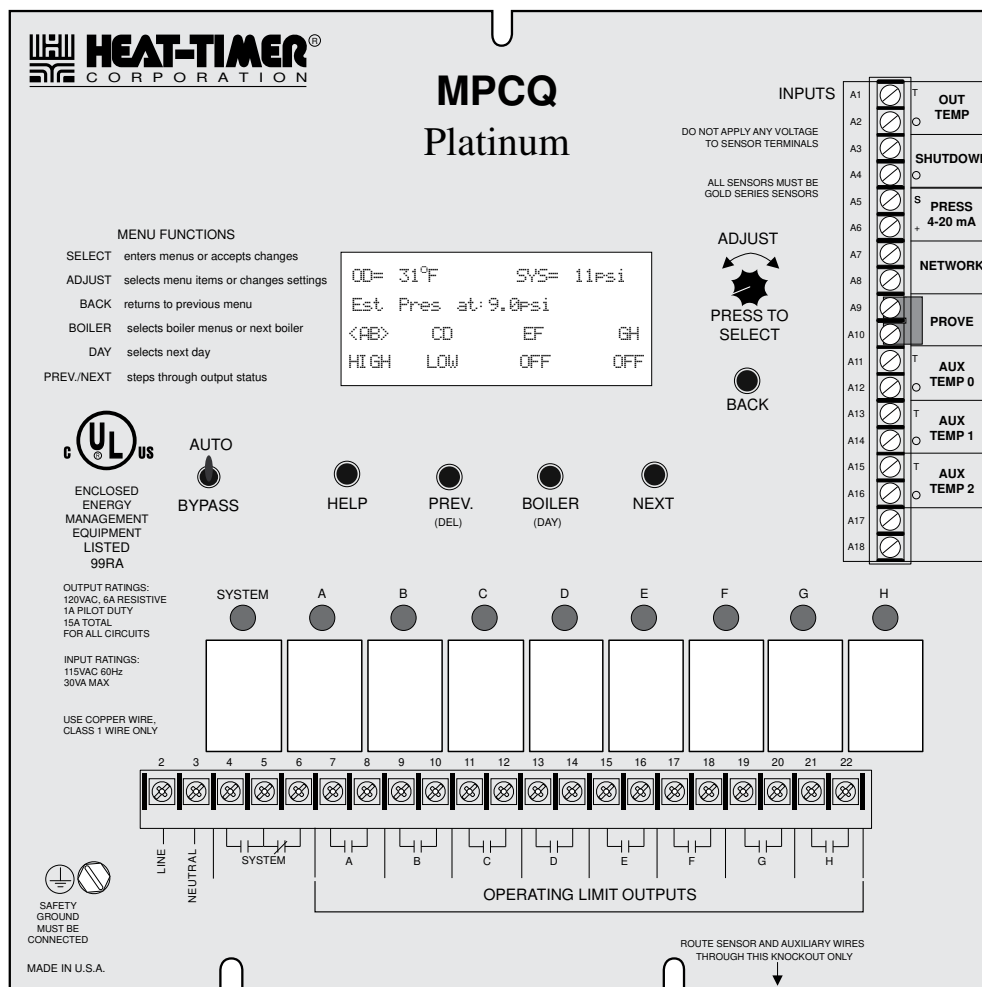

⚠ WARNING

The MPCQ Platinum is strictly an operating control. It CANNOT be used as a limit control. All boilers must have all safety and limit controls required by code. It is the responsibility of the installer to verify that all the safety and limits are working properly before the MPCQ Platinum is installed.

This control must be installed by a licensed electrician.

Contents

Panel Layout	3	Cycle Length Table.	21
Understanding Operation Concept	4	Day/Night Cutoff	21
Cycle Operation Concept	4	System Run-On	22
Set Point Operation Concept	5	Setback	22
PID Operation	5	Boost, Early Shutdown, and Boost Adjustment	22
OSS Operation.	5	Stage Settings	23
Setback	5	Reaction Time	23
Boost and Early Shutdown.	6	Purge Delay	23
Initial Pilot Program.	6	Minimum Run Time	24
Selecting the System Features	6	Standby Delay	24
Making Sure You Have the Right Control	7	Last Stage Hold	24
Installation.	8	Avoiding Conflicting Boiler Limits	24
Mounting the Control Box	8	Throttle.	24
Rear of Panel	8	Lead Boiler and Rotation Settings	25
Install the Sensors	9	Lead Boiler.	25
Outdoor Sensor Installation	9	Rotate Mode	25
Heating System Sensor (HSS) Installation	9	Boiler Operation Mode	26
Testing the Sensors	9	Schedules	26
Wiring	10	Day/Night Schedule	26
Power Input Wiring.	10	Copy Schedule.	28
Combustion Air Damper Wiring	10	Set Date and Time	28
Burner Stages Wiring	10	Vacation Schedule Setting	28
Wiring Network Sensors (Wireless and MIG)	11	Maintenance	29
Wiring Shutdown Terminals	11	System and Outdoor Sensor Trim	29
Wiring Prove Terminals	11	Fast Cycle	29
Wiring Aux Input Terminals.	11	Heat Establish Pressure and Pressure Lockout	29
Wiring to an Extension Panel	12	Password and Local Security	29
Wiring Extension Panel Lockout	12	Override Remote Changes	30
Connecting to the Internet	12	Shift	30
Connecting to the BACnet IP	13	Auto/Bypass	31
Menu Settings.	14	Communication	32
Setting the Control	16	Remote Interface.	32
Default Display and Changing Settings	16	Space Lock	32
Display Messages	16	Day Target	32
Startup Settings	17	Night Target	32
Sensor Type	17	Vacation Schedule	33
Operation Mode	17	Internet Communication	33
Cycle Length.	17	Internet ID	33
LOGIC	17	Internet Port forwarding Table	33
Boiler Type	18	Internet Alarms.	34
Total Boiler	18	BACnet Communication	35
On/Off Sequence	18	BACnet Communication Option	35
Sensor Fault	18	BACnet Device ID	35
Day Light Saving.	18	IP, Mask, and Gateway Address	35
System Settings	20	MPCQ Platinum BACnet Variable List	35
Season.	20	Platinum BACnet PICS Statement.	38
Set Point	20	Troubleshooting	39
Day/Night Heat Adjustment	21	Specifications	40

Panel Layout

Digital display shows the system status, Target, outdoor, and system temperatures. To view and adjust settings, press the Adjust/Select button.

Depress the knob to move forward through the menus and to accept changes. To change a setting's value, rotate the knob.

Depress the button to go back through the menus

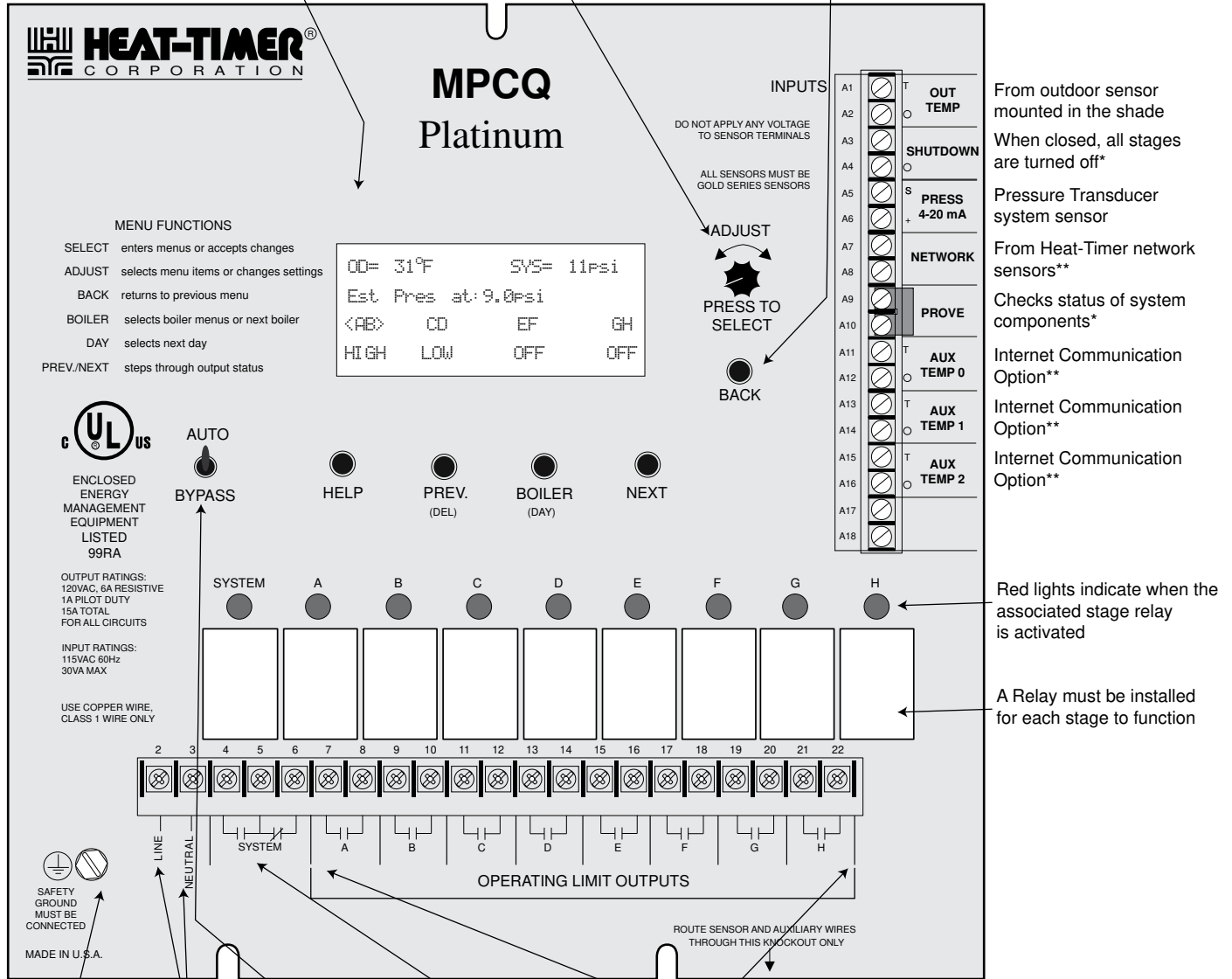

From outdoor sensor mounted in the shade

When closed, all stages are turned off*

Pressure Transducer system sensor

From Heat-Timer network sensors**

Checks status of system components*

Internet Communication Option**

Internet Communication Option**

Internet Communication Option**

Red lights indicate when the associated stage relay is activated

A Relay must be installed for each stage to function

Green Ground screw must be connected to Earth Ground

120VAC Power

BYPASS position overrides outputs so the burners are always active

Pump Output is active when MPCQ requires heat and during optional Run-On

Burner Stages Outputs are active when MPCQ requires Heat

* DRY CONTACT ONLY
 ** Only available with the Internet Communications package

Understanding Operation Concept

The Heat-Timer MPCQ Platinum is a microprocessor based control for multi-stage/multi-boiler steam heating systems. The control operates a bank of modular steam boilers, automatically activating and deactivating stages so as to provide the desired heat pattern for the application whether heating a building or a process application.

Cycle Operation Concept

Sample Mild Weather Cycle

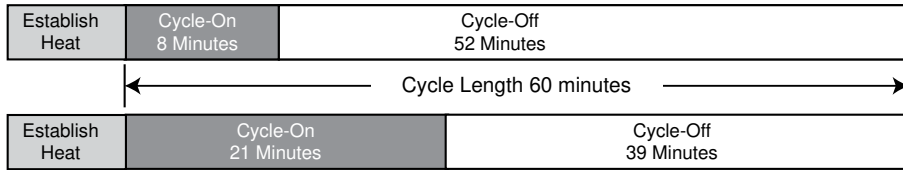

Sample Cold Weather Cycle

The control operates on the CYCLE principle which was created specifically for steam heating systems. The CYCLE concept was developed by Heat-Timer to overcome the inabilities of standard thermostatic controls to cope with the erratic properties of steam. Steam heat can not be switched on and off instantaneously. Instead, it takes time to build up a “head of steam”. And, once the system starts heating up, it has momentum which can not quickly be stopped.

By monitoring the outside temperature, the MPCQ Platinum is able to anticipate the heating needs of the building. Each fixed time CYCLE period (usually 60 minutes long but adjustable from 10 to 240 minutes) is divided into a heat-ON segment and a heat-OFF segment. The length of the ON segment will vary with the outside temperature. The colder it is outside, the longer the ON part of the cycle will be.

The MPCQ Platinum constantly checks the outside temperature by means of a solid state sensor located on the exterior of the building. At the same time it also monitors pressure by means of a heating system pressure sensor located in the common header. On the basis of this combined data, the MPCQ Platinum sends instructions to the heating plant to control the heat level in the building.

In addition to adjusting the length of the ON part of a cycle, the outdoor temperature acts as a system cutoff. When the outdoor temperature rises above an adjustable set point, the MPCQ Platinum will not call for any heat. When the outdoor temperature drops below the set point, the MPCQ Platinum will automatically begin controlling the heating cycles. Meanwhile, the heating system pressure sensor controls the number of boiler stages which are turned on, and the amount of steam pressure in the system. The effect of these two sensors combined is to provide an even comfortable level of heat throughout the building.

1. The MPCQ Platinum starts activating steam stages when the outside temperature falls below the Outdoor Cutoff (factory set to 55°F for the day and 40°F for the night, but fully adjustable). The MPCQ Platinum will continue to bring on more stages, and/or hold all the stages on, until the system pressure reaches the set point. This indicates that steam has gotten entirely through the system, or that pressure is established.
2. Once pressure is established, the heat-ON segment of the cycle will begin. During the ON part of the cycle, the MPCQ Platinum will activate as many stages as necessary to achieve and hold the pressure set point. Stages which may no longer be needed once set point pressure has been achieved will be turned off.
3. Once the ON part of the cycle has ended, the heat-OFF part of the cycle will begin. All the steam boilers will be turned off.
4. When the OFF part of the cycle is over, the MPCQ Platinum will once again start to establish pressure unless either the outside temperature has risen above the outdoor cutoff, or the header pressure is more than Heat Establish Pressure setting. See page 29.
5. The boilers will start firing once the steam pressure in the system falls below the Heat Establish Pressure setting. See page 29.

60 Minute Cycle
(Cycle-On=21 + Cycle-Off=39)

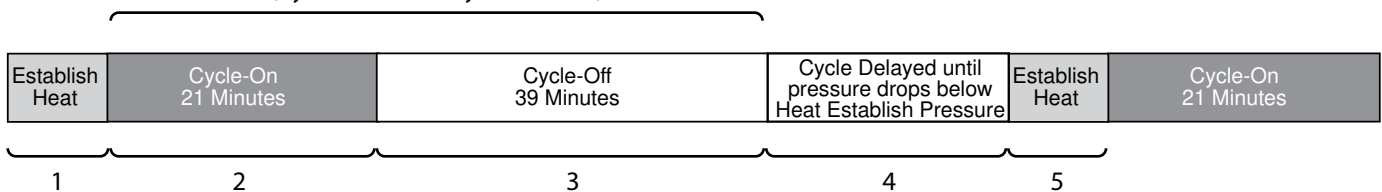

Set Point Operation Concept

The MPCQ Platinum can sequence stages using different logics. The PID Logic is primarily used to save energy on building heat. The OSS is used in application where fast response and pressure accuracy are the key factors.

PID Operation

(Available in Set Point Operating Mode)

PID control logic is primarily used for building set point heating. The logic will utilize two primary adjustable settings to add or subtract stages. The Reaction Time is used to turn on/energize stages. On the other hand, the Minimum Runtime is used to turn off/de-energize stages. On a call for heat and when the outdoor temperature is below the Outdoor Cutoff, the MPCQ Platinum will turn on/energize the lead boiler's lowest firing stage to start the Purge Delay. After the elapse of the purge period, the MPCQ Platinum will start calculating the Reaction Time. If after a full Reaction Time the control logic foresees additional stages are needed, the MPCQ Platinum will energize the following stage. If that stage was another boiler, that boiler has to go through a full Purge Delay before starting to calculate the Reaction Time for that stage. Otherwise, if the next stage was the higher firing stage on the same boiler, the Reaction Time will start from the moment the higher firing stage relay is energized.

When the MPCQ Platinum PID logic foresees that the system will overshoot, it will shutdown stages making sure that the last stage turned on/energized elapsed a full Minimum Runtime before it is turned off/de-energized. No additional stages will be turned off/de-energized until another full Minimum Runtime is elapsed. On the other hand, the lead stage will remain energized until the system reading exceeds the Set Point by the Last Stage Hold value in addition to satisfying the Minimum Runtime condition. That is, if the Set Point was 10 PSI and the Last Stage Hold was set to 2 PSI, the lead stage will remain energized until the system reaches 12 PSI and a full Minimum Runtime elapses. This is useful in protecting the lead stages from short cycling in mild weather conditions.

OSS Operation

(Available in Set Point Operating Mode)

OSS is used in fast reacting application as in process applications, where maintaining a set point is critical. The OSS utilizes the Throttle setting, as a mean to calculate the number of stages the MPCQ Platinum shall have on at any point. For every Throttle Range below the set point an additional stage shall be turned on/energized. That is, if the set point was 12 Psi and the Throttle setting was 2 Psi, if the System dropped below 10 Psi (12 Psi - 2 Psi), the lead stage will energize. With further decrease in the system value to 8 Psi (12 Psi - 2 Psi - 2 Psi), the second stage will energize.

As the system pressure rises towards the set point, stages will turn off. Using the previous example, when the system rise to 10 Psi, boiler B will de-energize leaving only boiler A on. Boiler A will remain on until the system rises a one full Throttle range above the set point. This will leave the lead boiler A on until the pressure rises to 14 Psi then turn off/de-energize.

Set Point = 12 Psi Throttle = 2 Psi Boilers (A, B, C, D, E, and F) Lead Stage =<A>

System Pressure	Throttle Ranges	Falling Pressure		Rising pressure	
		Stages Turned On	Stages On	Stages Turned Off	Stages On
14 Psi	-1	----	None	A	None
12 Psi	0	----	None	----	A
10 Psi	1	A	A	B	A
8 Psi	2	B	A + B	C	A + B
6 Psi	3	C	A + B +C	D	A + B +C
4 Psi	4	D	A + B +C + D	E	A + B +C + D
2 Psi	5	E	A + B +C + D + E	F	A + B +C + D + E
0 Psi	6	F	A + B +C + D + E + F	----	A + B +C + D + E + F

Setback

(Available in Set Point Operating Mode)

Whenever the MPCQ Platinum is at the Night schedule setting, it follows the Night Cutoff as its outdoor temperature system cutoff. It will then allow the system pressure to drop by the Setback setting and sequence the stages to hold that pressure for the full night period. The lower pressure provides the opportunity to save energy in applications where a cycle system does not apply.

Boost and Early Shutdown (Available in Cycle Operating Mode)

The Morning Boost is designed to return the building to comfortable ambient temperatures after the cooler Night (Save) period. The MPCQ Platinum will accomplish this by holding a constant steam pressure for a given period based on the Schedule Day #1 setting. If no boost is needed on a day of the week, simply DO NOT program the Day #1 setting, and use the Day#2 setting instead. See Boost on page 22.

The Early Shutdown should be used in commercial buildings where the building will be unoccupied in the Night time. A Vari-Boost as described above is run. In addition, the MPCQ Platinum will switch into the Night mode earlier than the latest Night setting for that day. The warmer it is outside, the earlier it will shift into Night. The Early Shutdown time is adjusted using the Morning Boost Adjustment Curve but works in the opposite fashion. The warmer it is outside, the earlier the MPCQ Platinum will shift to night. As it gets colder, the time between early shutdown and the last Night setting diminishes. The maximum amount of Early Shutdown is 90 minutes. See Early Shutdown on page 23.

Initial Pilot Program

Setting an Initial Pilot Program will ease the configuration of the MPCQ Platinum and will give the opportunity to utilize many of the energy saving features and give more comfortable heat when needed.

The program should consist of the following:

- Selecting the features that your system can utilize (page 6),
- Making sure you have the right control and accessories (page 7),
- Install the Control (page 8),
- Setting the System Startup (page 17),
- Setting the System Settings (page 20),
- Setting the Stage (page 23),
- Setting the Schedule (page 26),
- Setting the Communication (page 6).

Selecting the System Features

The MPCQ Platinum has been designed with steam commercial building heating as well as process heating as the primary functions. With this in mind, many of the MPCQ Platinum features can be utilized to ease, enhance, and improve your system performance. Some of these features are listed in this section.

Cycle or Set Point (Control Mode)

- The MPCQ Platinum can control the System either by adjusting the Cycle-On length according to the Outdoor Temperature (Cycle mode) or by maintaining an adjustable Set Point. The earlier relies on an Outdoor Sensor (supplied with the control) and achieves better fuel savings in building heating in addition to better comfort.

PID or Oversize (Control Logic)

- The MPCQ Platinum can use an algorithm (PID) to look at the rate of change in the System. If the System pressure changes quickly, the MPCQ Platinum will turn on or off stages quickly. If the pressure changes are slow or minor, the MPCQ Platinum will react slowly. The PID logic provides the most stable operation. Stages are brought on or off based on the rate of change of the System pressure and the impact a stage has on that rate.
- For applications where the stages are oversized for most load conditions, the MPCQ Platinum has Oversize System logic. The Oversize logic turns stages on or off proportionally, based on how far the System pressure is from the Set Point.

Number of Stages

- The MPCQ Platinum can be configured to control a variety of boiler-burner configurations. It can control up to 24 boiler stages using the MPCQ Platinum in addition to 2 Extension panels.
- The MPCQ Platinum can control up to 4 stage burners.
- Burner stages can be sequenced Lo/Hi/Lo/Hi or Lo/Lo/Hi/Hi. The first lets a burner fire its lower stage first followed by its higher stages. The second lets all burners lower stages to turn on before starting any higher burner stages. Both can only apply to 2-stage or more burners.

Adding up to 2 Extension Panels for Additional Stages

- When additional Stages are needed, the MPCQ Platinum can control up to 2 additional extension panels for a total of 24 stages.
- Extension panels have built-in Lockout input terminals. The MPCQ Platinum can isolate locked out boilers from the operation process and display their status.

Automatic Rotation among Stages

- Rotating the first burner to be activated on a call for output promotes even wear on all burners. The MPCQ Platinum has three modes of rotation: Manual, First-ON/First-OFF, or automatically every selected time period from every hour to every 41 days.

Schedules

- By setting an operating Schedule and Night Setback, you can save energy while providing comfortable heat to the building. The setting allows the MPCQ Platinum to use a different cycle curve as well as a different outdoor cutoff . In addition, it reduces space target temperature during the night or when building is unoccupied, i.e. office buildings and schools.
- During the day, Day Time settings will change cycle curve, outdoor cutoff, as well as space target. Each weekday can have up to 4 Day Time and 4 Night Time (Setback) settings. See Schedules on page 26.

Boost

- This feature lets the MPCQ Platinum bring the building up to temperature quickly after a Night period. When the MPCQ Platinum is to start the Boost, it starts its boost earlier than the Day #1 schedule setting. The length of boost is determined by the amount set by the Boost Adjustment for a period that is calculated using the outdoor temperature as a guide. See Boost on page 22.

Early Shutdown ESD

- This feature allows the MPCQ Platinum to shift to Night Setback before the last Night Time setting for that day. The Early Shutdown varies based on Outdoor temperature (OD). The warmer the Outdoor temperature the earlier the MPCQ Platinum will shift to Night Setback.. See Boost on page 22.

Remote Communication

- The MPCQ Platinum can be upgraded to Heat-Timer's BACnet (BAC controls) or Internet system (RINet controls) to monitor and control all MPCQ Platinum functions from a remote location. However, only the Internet communication package upgrade allows the MPCQ Platinum to accept additional sensors, to monitor their status, and to provide alarms deliveries to e-mail, text capable mobile phones, and the web if the sensor values are not in the correct range.

Vacation

- The MPCQ Platinum RINet (Internet controls only) can be set to have a third space target for a specified period. This can be used for vacation situation in schools. It offers the user a significant fuel savings during those periods.

Making Sure You Have the Right Control

If you need the MPCQ Platinum to do additional tasks that either is not listed or do not know how to configure them, contact Heat-Timer Corp. Sales Department either by Phone (973)575-4004, Fax (973) 575-4052, or by e-mail support@heat-timer.com.

Installation

Before beginning the installation, carefully evaluate your heating system. The MPCQ Platinum can control the heating system through these different methods:

- Controlling multiple single or multi-stage boilers.
- Controlling up to 24 burner stages by interfacing to a maximum of two Heat-Timer Extension Panels with lockout.

Mounting the Control Box

Locate an appropriate site

- Near the equipment to be controlled at eye level, or where the displays are easily visible and away from excessively high or low temperatures.
- The surface must be strong enough to hold the weight of the control and its enclosure.
- Leave 12" of clearance under the enclosure to ease conduit connection.

Remove the MPCQ Platinum from its enclosure

- Remove the top center screw holding the panel to the enclosure.
- Loosen the two screws holding the control to the bottom of the enclosure.
- Tilt the panel forward and then remove from enclosure. Make sure to unplug any control cables.
- Mount the enclosure to the surface using the holes provided.
- Connect the conduits and bring the wires to the bottom of the enclosure. Class 1 wiring must enter the enclosure through a different opening from class 2 wiring.

Rear of Panel

Activate the Battery

- Turn the MPCQ Platinum panel over to reveal the piggyback circuit board (CPU board).
- Remove the plastic strap that isolate the battery contacts.
- The battery is used to maintain date and time of the control during power loss periods.

▲ ALERT

Do not install the battery unless you plan to power and utilize the control at once. If the control is not powered, the battery will lose its charge in 100 days.

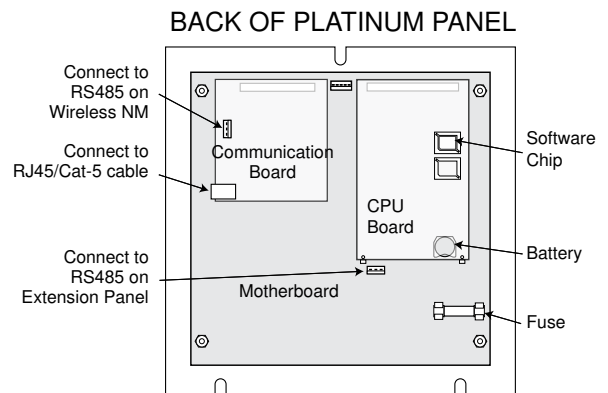

Connecting RS485 or Ethernet Cables

- Some panels might include an addition communication board on the back.
- When connecting an RS485 cables for extension communication, the round terminal connection must be screwed to one of the side knockouts on the enclosure.
- Ethernet connections (Internet or BACnet) must have the proper communication board installed.
- Remember that the upgrade to Internet or BACnet control requires adding a communication board and replacing the CPU board.
- When connecting the MPCQ Platinum to an Extension Panel, connect the RS485 to the back of the MPCQ Platinum. Use the center RS485 terminals on the motherboard. Do not use the RS485 terminals on the communication board.

▲ ALERT

When connecting the MPCQ Platinum to an Extension Panel, use the RS485 terminals on the motherboard. DO NOT use the RS485 on the communication board.

- Install the MPCQ Platinum back into its enclosure

Install the Sensors

Outdoor Sensor Installation

- Only use the Heat-Timer Outdoor Sensor included with the unit (HT# 904220-00).
- Locate the sensor in the shade on the north side of the building. The sensor should never be in direct sunlight.
- Be sure the location is away from doors, windows, exhaust fans, vents, or other possible heat sources.
- The sensor should be mounted approximately 10' feet above ground level.
- Adhere the Outdoor Label provided to the back of the sensor base.
- Use the Sensor Enclosure Base bottom knockout for the conduit. Use the locknut to hold the conduit and enclosure base together. Screw the cover to the base.
- If screws are used to affix the enclosure to the wall, make sure to seal around the sensor and wall except from the bottom.
- The sensor wires can be extended up to 500' using 2-conductor shielded cable (Belden #8760 or equivalent (#18/2)). Do not connect the shield at the sensor but at the control using the control Outdoor Sensor terminal marked with an "O" (A2).
- Do not run sensor wires in conduit with line voltage wiring.
- To enable the Cycle Mode, an outdoor sensor must be used. See Sensor Type settings on page 17.
- The outdoor sensor is used as an Outdoor Cutoff. The MPCQ Platinum will disable all stages when the outdoor temperature is above the adjustable Outdoor Cutoff temperature. See page 21. This feature will automatically be activated when an outdoor sensor is connected.

Outdoor Sensor

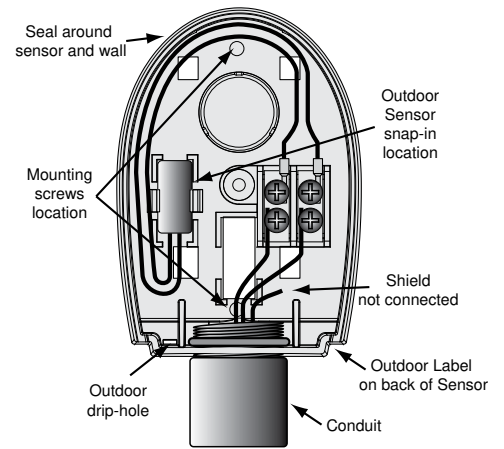

OUTDOOR SENSOR WIRING

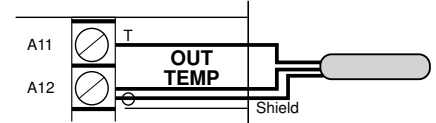

▲ ALERT

Determining the proper location for the Outdoor Sensor is very important. The MPCQ Platinum will base the heat on the outdoor temperature information it receives from this location. If the sensor is in the sun or covered with ice, its reading will be different from the actual Outdoor temperature (OD).

Heating System Sensor (HSS) Installation

Locating HSS

- Install the System Pressure transducer provided approximately 10' feet past the last boiler on the common supply header but before any takeoffs.
- When installing the pressure transducer, use a threaded Brass Isolation Tube (1/4" Brass Pigtail) attached to the steam header.
- The Red and Black wires can be extended up to 500' using shielded 2-conductor cable. The ground, shield, and reference tube on the transducer are not used.
- Do not use an external voltage source for the transducer as the MPCQ Platinum will provide the excitation voltage to the transducer.
- Connect the Black wire from the transducer to terminal A5 (S). Connect the Red wire to terminal A6 (+).
- Do not run sensor wires in conduit with line voltage wiring. Class 1 voltage must use a different knockout and conduit from class 2 voltage.

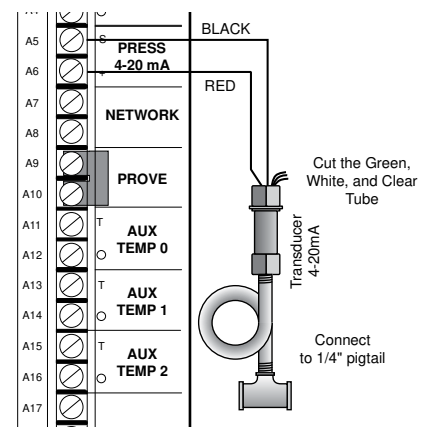

Testing the Sensors

- Power up the MPCQ Platinum.
- The control will go through a countdown, and then the top right of the display marked (SYS) will show the pressure read by the Heating System Sensor (HSS). The top left (OD) will show the temperature read by the Outdoor Sensor.
- If the display reads OPEN, SHORT, or an incorrect sensor value, follow the troubleshooting procedures on page 39.
- Wireless and MIG sensors readings can only be configured and viewed on the Internet through the ICMS website (<http://www.htcontrols.com>)

Wiring

- When connecting the MPCQ Platinum Output wiring, make sure to use the bottom knockouts. The use of any other knockouts or holes for the Outputs will void the control warranty.

Power Input Wiring

- Bring the power wires through the bottom left knockout of the enclosure. Do not bring wires through the sides or the top as this will interfere with servicing the control.
- Attach 120V 60 Hz to terminals *Line* and *Neutral*.
- Ground wiring must be connected to *Ground screw*. DO NOT use the neutral line as earth ground.
- Class 1 copper wire is required by UL.
- Class 1 voltages must enter the enclosure through a different opening from any Class 2 voltage.
- Heat-Timer recommends the installation of a Surge Suppressor and a Power Switch before the Power Line connection for safety and ease of service.

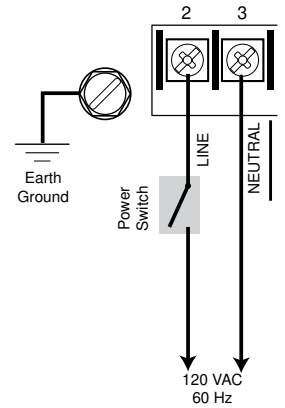

Combustion Air Damper Wiring

- The System relay is designed to operate a combustion air damper. The terminals are dry contacts only. They do not source any power. A separate power source is required.
- Wire the Normally Open (N.O.) dry contact terminals to the combustion air damper.
- Make sure the System relay is installed to allow the operation of the combustion air damper.
- The System relay can operate 1 Amp inductive or 6Amp resistive load at 120 VAC 60 Hz

Burner Stages Wiring

- Each of the MPCQ Platinum outputs operates a single stage on a burner. The outputs are dry contacts only. They do not source any power.
- Bring the boiler wires through one of the enclosure bottom knockouts.
- The Normally Open (N. O.) contacts for each stage must be in series with the boiler limit circuits.
- Make sure any wired stage's relay is installed to allow the operation of that stage.
- Each stage relay can operate 1 Amp inductive or 6Amp resistive load at 120 VAC 60 Hz

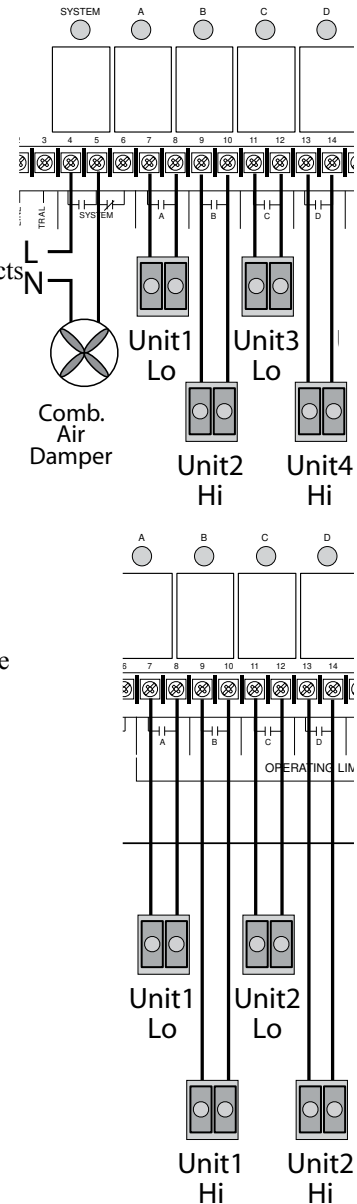

For up to 8 on/off boilers (without an Extension Panel)

- Attach the first boiler to the N. O. contacts marked A (terminals 7 & 8), the second boiler to B (9 & 10), and the third boiler to C (11 & 12), and so on.

For up to 4 lo/hi boilers (without an Extension Panel)

- The N. O. contacts for each boiler must be wired in series with the boiler limit circuit.
- Attach the low stage of the first boiler to the NO contacts marked A (terminals 7 & 8), the high stage to B (9 & 10)
- Attach the low stage of the second boiler to the N. O. contacts marked C (terminals 11 & 12), the high stage to D (13 & 14)

⚠ WARNING

All Output wiring must be run through the BOTTOM Knockouts. The use of other knockouts or drilled holes for the output wiring will void the control warranty.

⚠ WARNING

Never apply external voltage to the input terminals. Permanent damage will occur voiding the control warranty.

Wiring Network Sensors (Wireless and MIG)

(Requires Communication Package Upgrade)

- Remember that network sensors can only be configured remotely through the Internet (<http://www.htcontrols.com>).
- The MPCQ Platinum Network terminals can connect to up to 64 network sensors.
- When connecting to multiple sensors, a Mini-MIG control can be used to handle up to 16 sensors each. Multiple MIG's can connect to a single MPCQ Platinum.
- Wireless sensors can be used with transceivers to reduce building sensor wiring. The wireless Network Manager can be wired directly to the RS485 on the communication board. The balance of the wireless system will communicate its information to the wireless Network Manager.
- A variety of network sensors are available for the MPCQ Platinum:
 - Stack sensor
 - Count/Pulse sensor (connects to water meters.)
 - Oil tank level sensor (OTM)
 - Pressure, vacuum, and humidity transducers
 - Wireless temperature sensors system
 - Multiple Input Gateway (Mini-MIG) that gives the capability of connecting the control to multiple temperature or switch sensors.

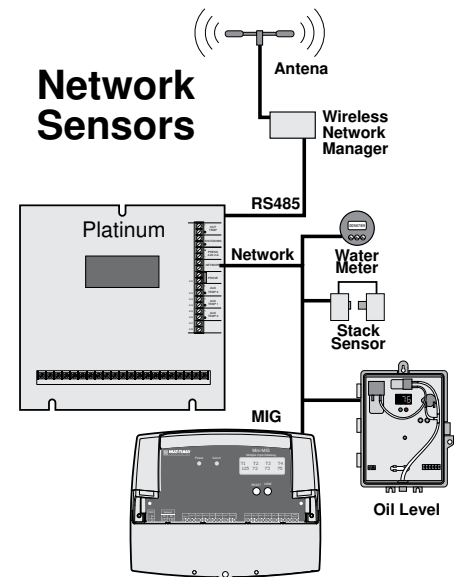

Wiring Shutdown Terminals

- This feature can be used whenever it is desirable to turn off the MPCQ Platinum from a remote location or another controller. A typical use for this feature would be to disable all heat from an Energy Management System (EMS).
- When the Shutdown is enabled (by shorting the *Shutdown* input terminals, all stage relays will de-energize. The System relay will continue to be energized for the Run-On delay period.
- The Shutdown signal must be a dry contact only. No voltage can be placed across the *SHUTDOWN* terminals - A3, A4

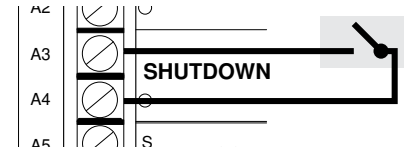

Wiring Prove Terminals

- The Prove feature checks system components operation before activating any of the boilers stages. It can be used to connect to the combustion air damper's end switch. That way the system relay will energize the combustion air damper and the prove will check if the damper is fully opened prior to activating any boiler stages.
- If the *PROVE* input terminals are open, the MPCQ Platinum will enable only the System relay. All stage relays will be de-energized when the *PROVE* input is open.
- If NO external conditions are to be met before the stage relays are energized, DO NOT remove the factory installed jumper across the *PROVE* terminals.
- The Prove signal must be a dry contact only. No voltage can be placed across the *PROVE* terminals A9, A10.

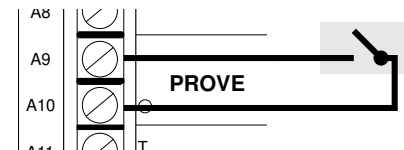

⚠ WARNING

The *PROVE* input CANNOT be used as a safety limit. All equipment must have its own certified limit and safety controls as required by local codes. Any safety interlock MUST be wired back to the boilers or other equipment as required by code.

⚠ ALERT

The *PROVE* terminals must be shorted for MPCQ Platinum to provide heat. DO NOT remove the factory installed *PROVE* jumper unless replacing it with a Prove signal.

Wiring Aux Input Terminals

(Requires Internet Communication Package Upgrade)

- Remember that Aux sensors can only be configured remotely through the Internet communication package.
- Each Aux terminal can connect to only one temperature (-30°F to 250F) or switch sensor.

Wiring to an Extension Panel

- The MPCQ Platinum can control up to 8 stages solely. By adding a Heat-Timer Extension Panel using RS485 cable, you can add an additional 8 boiler stages. A total of 2 Heat-Timer Extension Panels can be added to any single MPCQ Platinum totaling 24 boiler stages.
- Each Extension Panel has 8 Lockout inputs that can be used by the MPCQ Platinum when sequencing the boilers. Each Lockout controls one boiler regardless of the number of stages it has.
- When the MPCQ Platinum is connected to an Extension Panel, you will be able to scroll through each of the boilers using the *Adjust/Select* Knob.
- If a communication package is purchased with the MPCQ Platinum and the Extension Panel, the Internet will show the status of each boiler including the Extension Panel boilers.
- No Output cards are required for the Extension Panel when used with the MPCQ Platinum. You will need to install the proper relay for each of the stages needed.
- To be able to set the extension panel stages in the MPCQ Platinum Startup menu, the extension must be powered and connected to the MPCQ platinum. The MPCQ Platinum must then be re-powered up.

WIRING MPCQ PLATINUM TO MULTIPLE EXTENSION PANELS

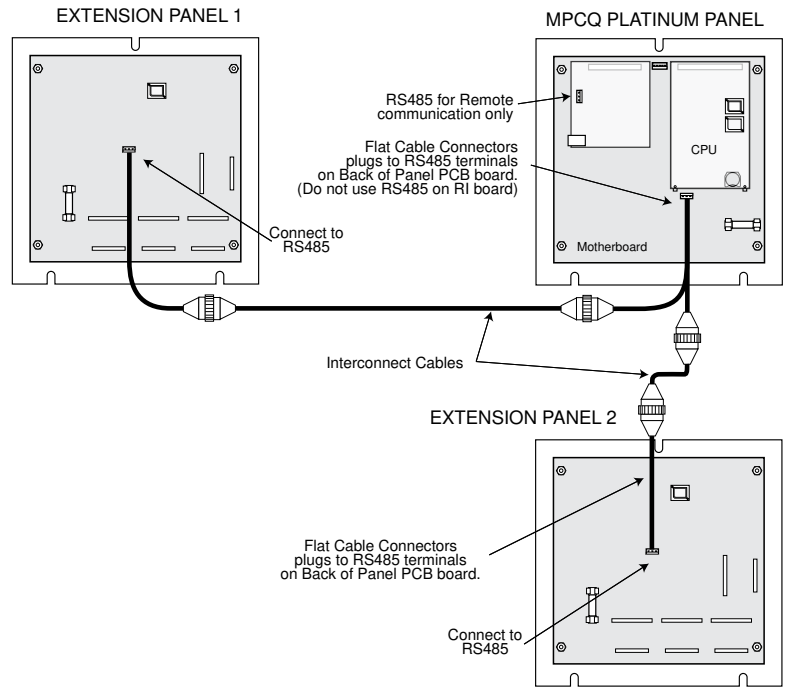

See Extension Panel documentation for additional wiring instructions.

Wiring Extension Panel Lockout

- Each Extension Panel has 8 Lockout inputs that can be used by the MPCQ Platinum when sequencing the boilers.
- The first Lockout terminals on the first Extension panel will control the first MPCQ Platinum boiler, the boiler that has stage A as its first stage. The second Lockout terminals on the first Extension panel will control the second MPCQ Platinum boiler.
- When a boiler Lockout terminals are shorted, the MPCQ Platinum will de-energize that boiler stages. In addition, it will omit that boiler from the sequencing process until those terminals are opened again. The display will show  under that boiler stages indicating the Lockout Status. I.e. If the MPCQ Platinum was controlling five 2-stage boilers (AB, CD, EF, GH (stages wired to MPCQ Platinum) and IJ (stages wired to the Extension)) and boiler AB and CD where energized at Hi. Then if, the Extensions first lockout input was shorted, boiler AB stages 91st boiler) will de-energize immediately. If any Lockout alarms were configured, a delivery will take place. See Internet Alarms on page 34.

Connecting to the Internet

- The MPCQ Platinum control comes either as a Standard without any communication or with Internet or BACnet communication.
- Any MPCQ Platinum with Internet communication control package has an Internet Communication Board installed on the back of the main board.
- Connect the Internet CAT5 Ethernet cable coming from the Internet Modem to the Internet RJ45 Communication socket on the back of the MPCQ Platinum communication board.
- If the control is sharing the Internet connection with other computers, an Internet Router or Internet server must be used. See Internet Setting on page 33.
- If required, set the MPCQ Platinum Internet Settings as described on page 33.

Internet Communication Connection to Back of Control

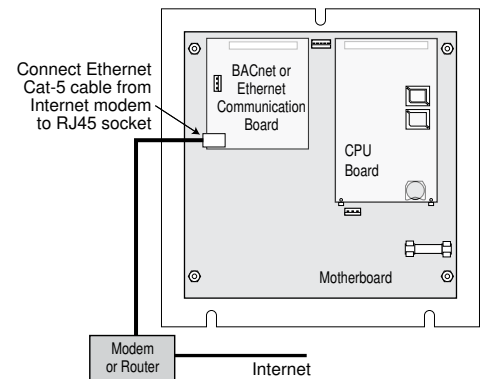

Connecting to the BACnet IP

- The MPCQ Platinum control comes either as a Standard without any communication or with Internet or BACnet communication.
- Any MPCQ Platinum with BACnet communication control package has a BACnet Communication Board installed on the back of the main board.
- Connect the BACnet CAT5 Ethernet cable coming from the network to the BACnet RJ45 Communication socket on the MPCQ Platinum communication board.
- Set the MPCQ Platinum BACnet Network Settings as described on page 35.

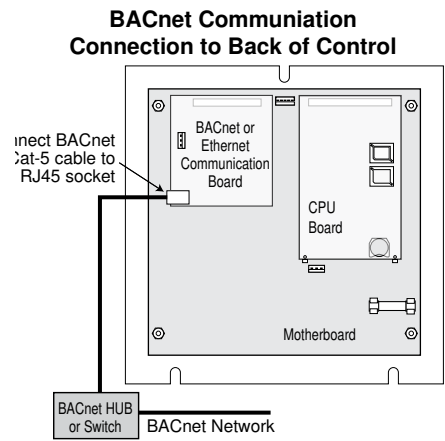

Menu Settings

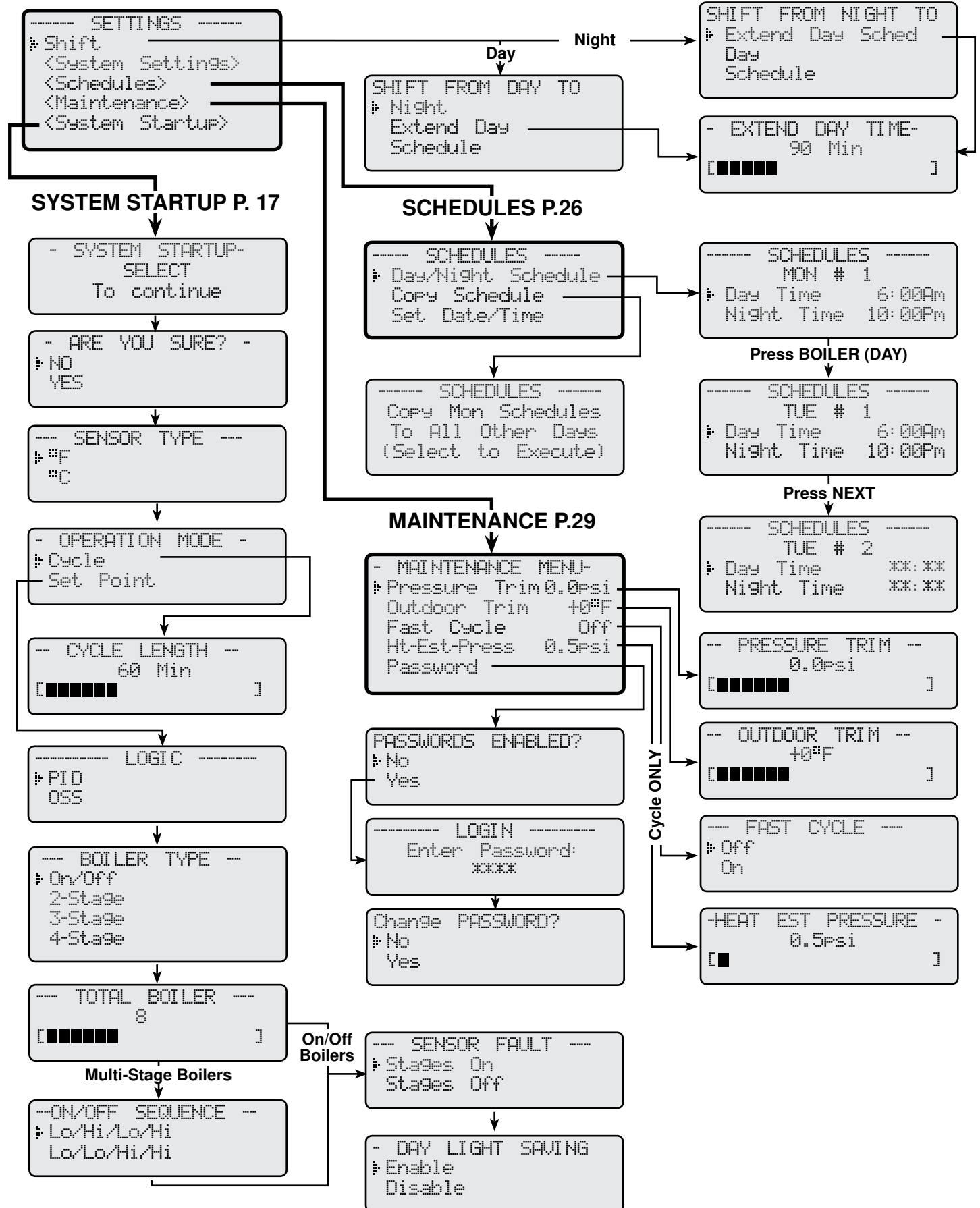

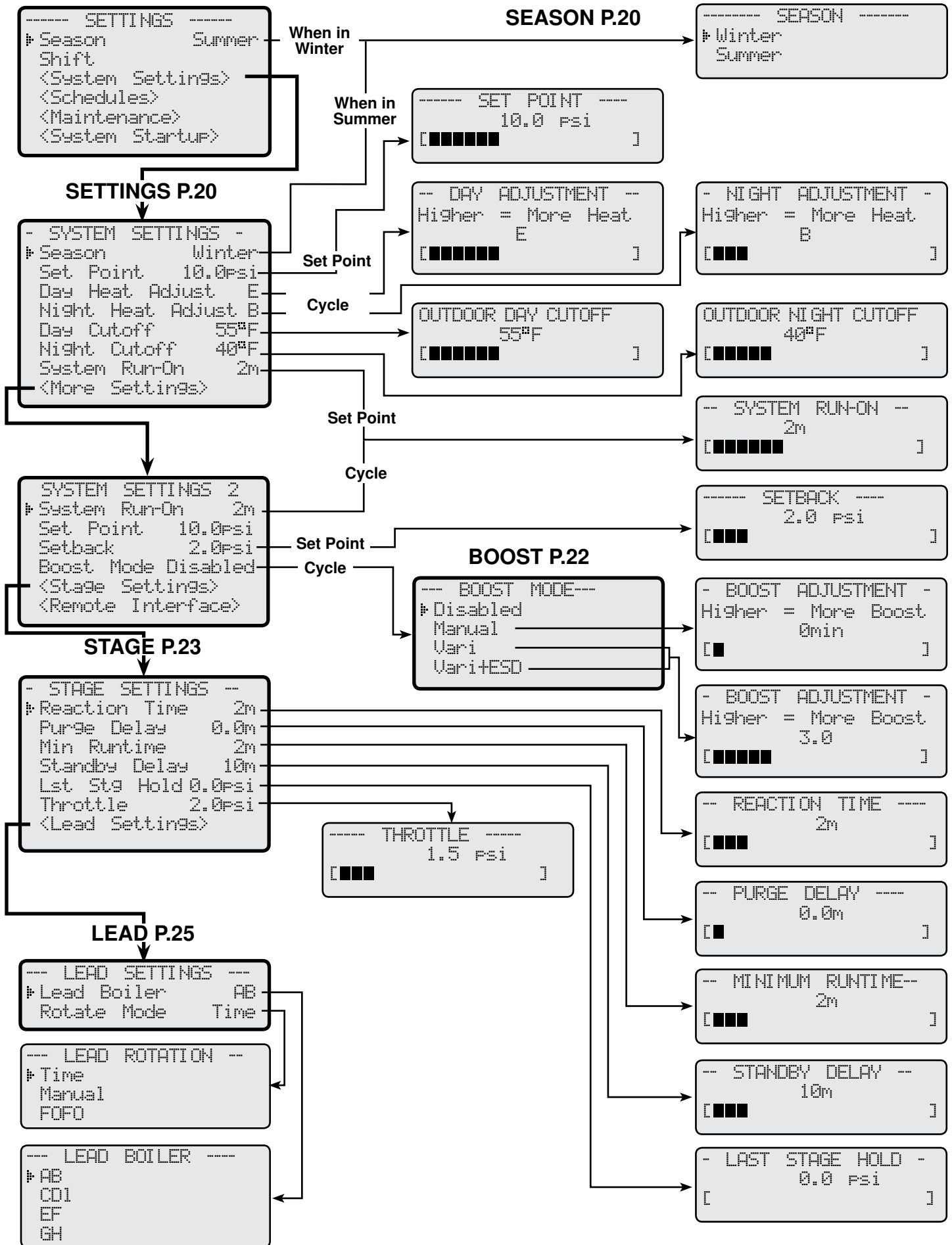

Setting the Control

Default Display and Changing Settings

The MPCQ Platinum is equipped with an 80 character (20 character per row x 4 rows) digital display. The Display's default screen is divided into 4 rows of text as per the diagram.

The following is a list of the buttons and knobs and their functionality:

SELECT/ADJUST Is a turning knob and a push button. When turned in the default screen will scroll through all the boilers.

When pushed will enter the Settings menu. In menus, it scrolls through the available options when dialed. When clicked, it accepts the selected value.

BACK When in the default screen, pushing it will display the date, time, Space Average, and the Auxiliary input status. When in any menu, pushing it will go back to the parent menu.

NEXT In the default screen, it scrolls forward through the boilers. In Boiler Menu, goes to the next setting. In Schedules, goes to next schedule time for that day.

BOILER (DAY) When in the default screen, will display the Boiler Menu. In the Boiler menu, switches between boilers. In Schedules, switches between different weekdays.

PREV. (DEL) In the default screen, it scrolls backward through the boilers' status. In Schedules, it clears a specific schedule setting. In the Boiler Menu, will display the previous boiler settings.

HELP When clicked on a specific menu item will provide help instructions.

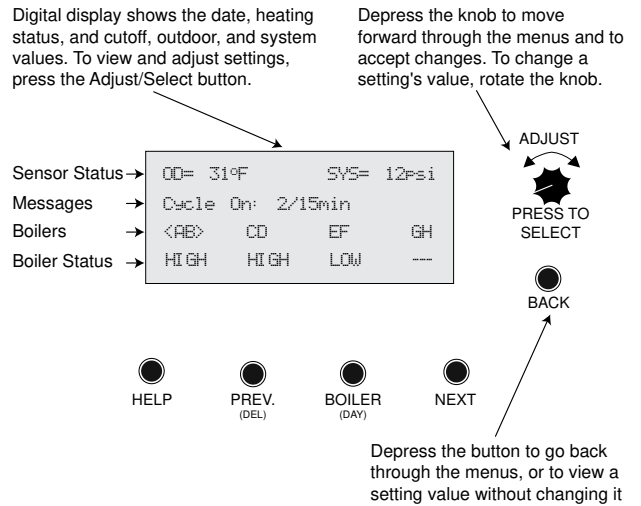

When powering up the MPCQ Platinum for the first time, it will take you through an 70 second count down followed by the System Startup Settings then another 10 second boot setup and finally end with the default system screen. Once the control is mounted and wired, set up an initial pilot program.

- Set and adjust System Startup Settings (page 17)
- Set and adjust System Settings (page 20)
- Set and adjust Stage Settings (page 23)
- Set and adjust Maintenance (page 29)
- Set and adjust Schedules (page 26)

Display Messages

The MPCQ Platinum normal display layout reserved the second line for message indications. The following is a list of the most common Message Display Line information:

- Est Pres at 10 psi The MPCQ Platinum is set to Cycle Operation Mode and is energizing stages to establish heat prior to starting a heating cycle. See Cycle Operation Concept on page 4.
- Cycle On: 1/5 min The MPCQ Platinum is in the Cycle-On period for a minute out of a total Cycle-On of 5 minutes. See Cycle Operation Concept on page 4.
- Cycle Off: 6/60 min The MPCQ Platinum is in the Cycle-Off period. Only 6 minutes has elapsed from the total cycle of 60 minutes. See Cycle Operation Concept on page 4.
- Fast C/D: 68°F The Boost option is Vari+ESD. The MPCQ Platinum is turning off stages at the end of the last Day schedule setting for the Fast Cool Down until the space average temperature drops below 68°F (Night Space Target). See Fast Cool Down on page 22.
- Pres L/O: 2 psi In Cycle Operation Mode the MPCQ Platinum is in Pressure Lockout until the pressure drops to 2 psi. See Heat Establish Pressure on page 29.
- Space L/O: 71°F In Cycle Operation Mode the MPCQ Platinum is in Space Lockout until the space average drops below 71°F. See Space Lock on page 32.
- Vari Boost Active The MPCQ Platinum has started a Vari Boost in a Cycle Operation Mode. See Boost on page 22.
- Manual Boost 29 min The MPCQ Platinum has started a Manual Boost in a Cycle Operation Mode. Only 29 minutes are left to terminate the Manual Boost. See Boost on page 22.
- Summer The control is set to Summer. No heat is active. See Season on page 20.
- No Call For Heat The Outdoor temperature is above the Outdoor Cutoff. See Day/Night Cutoff on page 21.

- Shutdown Active The *SHUTDOWN* Terminals are Shorted. No boilers are active. See Shutdown on page 11.
- Sensor Fault Either the Outdoor or the System sensor is reading Short or Open. All the boilers are either On or Off depending on the Sensor Fault setting on page 18.
- LSH: 12 psi The Lead boiler is in Last Stage Hold. This example shows that the lead stage will turn off when system pressure reaches 12 Psi. See Last Stage Hold on page 24.
- TGT= 10 psi In a Set Point Operation Mode the MPCQ Platinum is sequencing stages to hold the Set Point in Day schedule. See Set Point on page 20.
- Setback to 10 Psi In a Set Point Operation Mode the target has changed to the setback value due to Night Schedule. See Setback on page 22.
- Prove Failure After boilers have run for a while, Prove signal was opened. The boiler relays will de-energize. However, the System relay will remain energized. See Wiring Prove on page 11.
- Waiting for Prove There is a call for heat and the Prove terminals are open before the boilers start firing. The boiler relays will be de-energize while the System relay is energized. See Wiring Prove on page 11.
- Sys RunOn: 59sec The last boiler stage has turned off and the System relay will remain energized for the additional Run-On Delay of 59 seconds. See System Run-On on page 22.

Startup Settings

SELECT: *Settings/System Startup*

If entering this menu option after the control has been set, several warnings will display prior to entering the Startup menu to emphasize that any changes in this menu will drastically change the way the control behaves.

⚠ ALERT

A good practice after performing any Startup menu modifications is to check all operating settings and adjustments to match the new settings.

Sensor Type

°F for Fahrenheit or °C for Celsius

Default: °F Fahrenheit

SELECT *Settings/System Startup/.../Sensor Type*

- It allows the user to display temperature information and settings in either °F (Fahrenheit) or °C (Celsius).

```

--- SENSOR TYPE ---
▶ #F
  #C
  
```

Operation Mode

Cycle or Set Point

Default: Cycle

SELECT *Settings/System Startup/.../Operation Mode*

- The MPCQ Platinum can control the sequencing of the steam boilers either by using the cycle concept (See page 4) or by maintaining an adjustable Set Point.
- When Cycle is selected, the MPCQ Platinum will adjust the cycle on length according to the Outdoor Temperature and the Heat Adjustment. This option will provide more comfort and fuel savings for building heating applications.
- The Set Point option is useful when sequencing the boilers to maintain a specified fixed target. This can be used in building heating where additional zone distribution is available or in processing applications.

```

- OPERATION MODE -
▶ Cycle
  Set Point
  
```

Cycle Length

(Available with Cycle Operating Mode only)

Adjustable from 10 to 240 minutes

Default: 60 minutes

SELECT *Settings/System Startup/.../Cycle Length*

- With most cast iron radiation, choose a 60 minute cycle. If the radiators are very large or the system is oversized, choose a 90 minute cycle.
- For convector or baseboard radiation, choose a 30 minute cycle.
- For air handlers or blower units, choose a 20 minute cycle.
- The cycle length can be adjusted from 10 to 240 minutes, but it is recommended to start with the guidelines above.

```

--- CYCLE LENGTH ---
          60 Min
[■■■■■■■]
  
```

LOGIC

(Available with Set Point Operating Mode only)

PID, OSS Default: PID

SELECT *Settings/System Startup/.../Logic*

- The PID option allows the MPCQ Platinum to sequence stages based on PID. The PID relies on the rate of change in the System Temperature. The PID logarithmic calculations foresee changes and sequence stages based on those changes. It is the most efficient operation for most heating systems. See PID Operation on page 5.

```

----- LOGIC -----
▶ PID
  OSS
  
```

- When PID is Selected, the following are the settings that directly affects this modes operation:
 - Reaction Time (See page 23) *SELECT Settings/System Settings/More Settings/Stage Settings/Reaction Time*
 - Purge Delay (See page 23) *SELECT Settings/System Settings/More Settings/Stage Settings/Purge Delay*
 - Minimum Run Time (See page 24) *SELECT Settings/System Settings/More Settings/Stage Settings/Min Runtime*
 - Standby Delay (See page 24) *SELECT Settings/System Settings/More Settings/Stage Settings/Standby Delay*
 - Last Stage Hold (See page 24) *SELECT Settings/System Settings/More Settings/Stage Settings/Lst Stage Hold*
- The Oversize option sequence stages based on how many Throttling ranges is the system temperature away from the Target Temperature. At one Throttling range below the Set Point, only one stage will be on. For each additional Throttling range below the Set Point, an additional stage will be activated. The last stage on will be allowed to exceed the Set Point by one Throttling range before turning off that stage. This helps to prevent the last stage from short cycling. See OSS Operation on page 5.
- When Oversize (OSS) is Selected, the following are the settings that directly affects this modes operation:
 - Throttle (See page 24) *SELECT Settings/System Settings/More Settings/Stage Settings/Throttle*

Boiler Type

On/Off, 2-Stage, 3-Stage, or 4-Stage

Default: On/Off

SELECT Settings/System Startup/.../Boiler Type

- The MPCQ Platinum can control multiple multi-stage boilers.
- The number of stages per boiler multiplied by the number of boilers will give the total number of stages the MPCQ Platinum will control.

```

--- BOILER TYPE ---
▶ On/Off
  2-Stage
  3-Stage
  4-Stage
    
```

Total Boiler

Adjustable from 1 to 24 depending on Boiler Type

Default: varies

SELECT Settings/System Startup/.../Total Boiler

- The MPCQ Platinum can control up to a total of 24 stages using a maximum of two Extension panels. Enter the total number of boilers to be controlled.
- Make sure that the extension panels are connected (See page 12) and powered before adjusting the Total Boiler value.

```

--- TOTAL BOILER ---
      8
[■■■■■■]
    
```

On/Off Sequence

(Not Available for on/Off Boilers)

Lo/Hi/Lo/Hi or Lo/Lo/Hi/Hi

Default: Lo/Hi/Lo/Hi

SELECT Settings/System Startup/.../On-Off Sequence

- The MPCQ Platinum can sequence multi-stage burners by boiler (Lo/Hi/Lo/Hi). In this option, the MPCQ Platinum will start the first boiler's lowest stage followed by the remaining stage for that boiler. Then, do the same for the following boilers.
- If the Lo/Lo/Hi/Hi option was selected, the MPCQ Platinum will start the first boiler's lowest stage followed by the second boiler's lowest stage until all boilers set to Auto mode has all their lowest stages on. When more stages are need, the MPCQ will start the secondary stages starting with the lead boiler followed by the next and so on. This option is more efficient for many copper tube and low mass boilers.

```

---ON/OFF SEQUENCE ---
▶ Lo/Hi/Lo/Hi
  Lo/Lo/Hi/Hi
    
```

Sensor Fault

Stages On or Stages Off

Default: Stages On

SELECT Settings/System Startup/.../Sensor Fault

- This selection determines the status of the stage relays when either the Outdoor Sensor or System Sensor is at fault, sensor reading will display either OPEN or SHORT. In addition, the Display second line will show SENSOR FAULT.
- When Stages On is selected and a sensor is at fault, the System relay in addition to all the stages relays will energize. This will allow all the boilers to run on their own limits.
- When Stages Off is selected and a sensor is at fault, all boiler stages relays and system relay will de-energize.

```

--- SENSOR FAULT ---
▶ Stages On
  Stages Off
    
```

Day Light Saving

Enable or Disable

Default: Enable

SELECT Settings/System Startup/.../Day Light Saving

- Enable this feature in areas where Day Light Saving is observed to account for the time changes without having to manually change the time twice a year.

```

- DAY LIGHT SAVING
▶ Enable
  Disable
    
```

Date and Time Setting

Year, Month, Day, Time

SELECT *Settings/System Startup/.../Set Year*

- Entering the correct date and time assures that the MPCQ Platinum will follow the schedules based on the correct time.
- Use the *Select/Adjust* button to change and accept date and time values.
- Internet controls will automatically adjust their date and time according to the time zone specified in the Internet Building configuration.

The image shows three sequential screenshots of the MPCQ Platinum date and time setting interface. Each screenshot is enclosed in a rounded rectangular border.

- Top Screenshot:** Titled "SET YEAR". It shows the year "2000" in the center. Below the year is a row of seven black squares representing a numeric keypad. The entire screen is enclosed in brackets [] on the left and right sides.
- Middle Screenshot:** Titled "SET MONTH". It shows two options: "January" and "February". A cursor is positioned to the left of "January". The screen is enclosed in brackets [] on the left and right sides.
- Bottom Screenshot:** Titled "SET DAY". It shows the number "1" in the center. Below the number is a single black square representing a numeric keypad. The screen is enclosed in brackets [] on the left and right sides.

System Settings

SELECT: *Settings/System Settings*

The System Settings and System Settings 2 menus allow for adjusting and fine-tuning the system for enhanced comfort and more fuel savings. The MPCQ Platinum behavior differs based on the selected Control Mode (see Startup Settings on page 17).

Cycle

- Season (Winter or Summer)
- Day/Night Heat Adjustments (page 21)
- Day/Night Outdoor Cutoffs (page 21)
- System Run-On (page 22)
- Set Point (page 20)
- Boost Mode (page 22)
- Stage Settings (page 23)
- Remote Interface (Utilized with Remote Communication Only) (page 6)

Set Point

- Set Point (page 20)
- Setback (page 22)
- Season (Winter or Summer)
- Day/Night Outdoor Cutoffs (page 21)
- System Run-On (page 22)
- Night Setback (page 22)
- Stage Settings (page 23)
- Remote Interface (Utilized with Remote Communication Only) (page 6)

```
- SYSTEM SETTINGS -
# Season           Winter
Set Point         10.0psi
Day Heat Adjust   E
Night Heat Adjust B
Day Cutoff        55°F
Night Cutoff      40°F
System Run-On     2m
<More Settings>
```

```
SYSTEM SETTINGS 2
# System Run-On    2m
Set Point         10.0psi
Setback           2.0psi
Boost Mode Disabled
<Stage Settings>
<Remote Interface>
```

```
----- SEASON -----
# Winter
Summer
```

Season

Winter or Summer

SELECT *Settings/Season*

SELECT *Settings/System Settings/Season*

- When switched to Summer, the MPCQ Platinum will de-energize all the boiler stages immediately and will de-energize the System relay after the Run-On Delay.
- When in Winter, the MPCQ Platinum will activate the heat whenever the Outdoor temperature (OD) falls below the Outdoor Cutoff setting. Therefore, adjust this setting to Winter during the heating season.
- When the heating season is over, it is a good practice to switch the MPCQ Platinum to Summer setting.

Default: Winter

when in Winter

when in Summer

⚠ ALERT

DO NOT turn power off to the MPCQ Platinum when heating season is over. If you do so, the battery will run down and will have to be replaced. Instead switch to Summer.

Set Point

Adjustable 0.0 psi to 30.0 psi

SELECT *Settings/System Settings/Set Point*

SELECT *Settings/System Settings/More Settings/Set Point* in Cycle Operation Mode

- The Set point is the pressure the MPCQ Platinum will use to control the system.
- The MPCQ Platinum will add, subtract, or hold the stages to maintain the system pressure around the Set point.
- The system is expected to fluctuate around the set point. The amount of fluctuation depends on the System and Stage Settings.
- In Cycle Operation Mode, the Set Point is the pressure at which heat has gotten all the way through the buildings radiation system. Ideally, this point should be set to the system pressure when the last radiator in the building gets warm.
- To set the System Sensor Set Point, use the following procedure:
 1. Turn the heating system off and wait until the radiators are cool when touched.
 2. Set the boilers high pressure operating limits to the highest value the manufacturer or system recommends.
 3. Set the System Sensor Set Point to 10 PSI.
 4. Start the heating system.
 5. Go to the furthest radiator (in terms of longest piping distance) or to a radiator in a location known to get heat last.
 6. Wait until the radiator is warm. Depending on the steam distribution, this may take up to half an hour, or even more.
 7. Return to the MPCQ Platinum control and read the current System pressure. Adjust the System Sensor Set Point down to that pressure. The Cycle-On message comes on.

Default: 10.0 psi

in Set point Operation Mode

in Cycle Operation Mode

```
----- SET POINT -----
                10.0 Psi
[■■■■■■■ ]
```

⚠ WARNING

The boiler operating limit controls must be set above the System Sensor Set Point. Otherwise the boilers will run on their limits.

Day/Night Heat Adjustment

(Available in Cycle Operating Mode Only)

Adjustable from A to P

Default: E/ B

SELECT *Settings/System Settings/Day Heat Adjust*

SELECT *Settings/System Settings/Night Heat Adjust*

- The Heat Adjustment change the amount of heat provided based on outdoor temperature. An A setting gives the least amount of heat at any given outside temperature, and a P setting gives the most heat.
- Note that the length of the ON part of the cycle is based on the Outdoor Cutoff minus the actual Outdoor Sensor reading. This means if you set both the Day and Night Heat Adjustments to the same value, you will get less heat at night. For instance, with both Heat Adjustments set to F and the factory set Outdoor Sensor Set Points of 55°F for Day and 40°F for Night, if the outdoor temperature is 25°F the On part of the cycle will last for 15 minutes in the Day, and only 7 minutes at Night.
- If the building is too cold in cold weather, adjust the appropriate setting up one letter. That is, from F to G. Then wait at least 24 hours before evaluating if the adjustment was sufficient. Similarly, if it is too hot in the cold weather, adjust the setting one letter and wait for at least 24 hours.

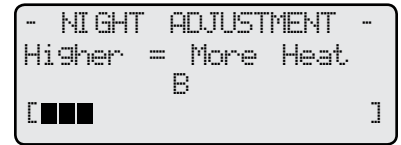

Cycle Length Table

Outdoor Cutoff Minus Outdoor Temperature

	95°F	90°F	85°F	80°F	75°F	70°F	65°F	60°F	55°F	50°F	45°F	40°F	35°F	30°F	25°F	20°F	15°F	10°F	5°F	1°F
A	45	41	37	33	29	25	22	18	15	13	10	8	5	3	2	0	0	0	0	0
B	57	51	46	41	37	33	28	25	21	18	15	12	9	7	5	3	1	0	0	0
C	C	59	54	48	43	38	33	29	25	21	18	15	12	9	7	5	3	1	0	0
D	C	C	C	55	49	43	38	34	29	25	21	17	14	11	9	6	4	2	1	0
E	C	C	C	C	55	49	43	38	33	28	24	20	17	13	10	8	6	4	2	1
F	C	C	C	C	C	55	49	43	37	32	27	23	19	15	12	9	7	5	3	2
G	C	C	C	C	C	C	54	48	42	36	31	26	22	18	14	11	8	6	4	3
H	C	C	C	C	C	C	C	53	47	40	35	29	25	20	16	13	10	7	5	4
I	C	C	C	C	C	C	C	59	52	45	39	33	27	23	18	15	11	9	6	5
J	C	C	C	C	C	C	C	C	58	50	43	37	31	25	21	16	13	10	7	6
K	C	C	C	C	C	C	C	C	C	56	48	41	34	28	23	19	15	11	8	7
L	C	C	C	C	C	C	C	C	C	C	53	45	38	32	26	21	16	13	9	7
M	C	C	C	C	C	C	C	C	C	C	59	51	43	35	29	23	18	14	11	8
N	C	C	C	C	C	C	C	C	C	C	C	56	47	39	32	26	20	16	12	9
O	C	C	C	C	C	C	C	C	C	C	C	C	53	44	36	29	23	17	13	10
P	C	C	C	C	C	C	C	C	C	C	C	C	59	49	40	32	25	19	15	12

Minutes ON (based on 60 minute cycle length)

Day/Night Cutoff

Adjustable from 20°F to 100°F

Default: 55°F/ 40°F

SELECT *Settings/System Settings/Day Cutoff*

SELECT *Settings/System Settings/Night Cutoff*

- The Day/Night Cutoffs will determine when can the MPCQ Platinum start heating the System. When the Outdoor temperature (OD) is above the Outdoor Cutoff, the MPCQ Platinum will turn off all burner stages. When the Outdoor temperature (OD) falls below the Outdoor Cutoff, the MPCQ Platinum will sequence the boiler stages for heating.
- In Cycle heating applications, in addition to using the Outdoor Cutoff as a start heating point, the difference between Outdoor Cutoff and the current outdoor temperature is used in determining the Cycle-On length period. See Cycle Length Table on this page.

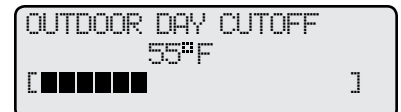

System Run-On

Adjustable from 0 to 60 minutes

Default: 2 minute

SELECT *Settings/System Settings/System Run-On*

- The System relay can control a combustion air damper. When the Outdoor temperature increases 2°F above the Outdoor Cutoff after the last burner stage relay has de-energized, the System relay will stay on for a period of time set by the System Run-On. This allows the combustion air damper to bring fresh air into the building.



Setback

(Available in Set Point Operating Mode Only)

Adjustable 0.0 psi to 10.0 psi

Default: 2.0 psi

SELECT *Settings/System Settings/More Settings/Setback*

- When in Set Point Operating Mode, the MPCQ Platinum has two heat levels. The Day Time setting is for when a building is occupied and people are active. It follows that Day schedule. The Night Time settings hold a lower pressure set point when the building is unoccupied and it will follow the Night schedule.
- The Night Time setting lowers the pressure of the system by the setback indicated. In other words, if the control is in Setback, the MPCQ Platinum will subtract the value of the Night Setback setting from the Set Point setting and use the result as the new target.



Boost, Early Shutdown, and Boost Adjustment

(Available in Cycle Operating Mode Only)

Disabled, Manual, Vari, and Vari+ESD

Default: Vari

Manual Boost Adjustment: 0 to 120 minutes

Default: 0 minutes

Vari Boost Adjustment: 0.1 to 6.4

Default: 3

SELECT *Settings/System Settings/More Settings/Boost Mode*

- The Morning Boost is designed to return the building to comfortable ambient temperatures after the cooler Night (Save) period. The MPCQ Platinum will accomplish this by holding a constant steam pressure for a given period based on the Schedule Day #1 setting. See Schedules on page 26.
- If no boost is needed on a day of the week, simply DO NOT program the Day #1 setting, and use the Day #2 setting for any Day starting time.
- To set up the Morning Boost, you must select the type of Boost and its amount. There are three types of Boost:

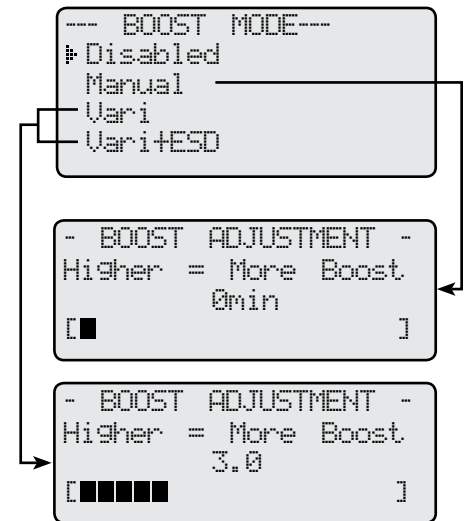

Manual

- This Boost begins at the Day #1 time, and lasts for as many minutes as set by the Boost Adjustment. This type of Boost does not adjust with outside temperature and is not affected by the space temperature.

Vari-Boost

- This boost begins earlier than the Day #1 time. The colder the outdoor temperature, the earlier the Vari-Boost will start. A Vari-Boost curve of 0.1 gives the shortest Boost period, and a curve of 6.4 gives the longest Boost period.
- If Space Lockout was enabled, the Vari-Boost can extend up to an hour past the Day #1 schedule setting trying to satisfy the Day Space Target.
- Whenever Vari-Boost is selected, it will have an added 15 minute Warm-up time. This accounts for the time it takes for the boilers to establish pressure from a cold start, and is automatically added to the Boost time. So that, the total Boost period is equal to Boost time plus the Warm-up time.

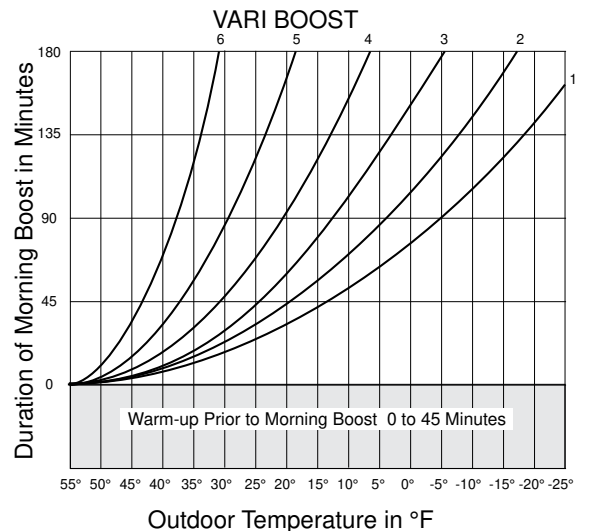

- If Warm-up Learn was enable over the Internet, the MPCQ Platinum will learn the length of time it takes the system sensor to reach the Set Point over multiple days and apply that to the following Warm-ups.
- Both Warm-up and Warm-up Learn can only be deactivated/activated through the Internet.

Early Shutdown

- This should be used in commercial buildings where the building will be unoccupied in the Save (Night) times. A Vari-Boost as described above is run. In addition, the MPCQ Platinum will switch into the Night mode earlier than the latest Night setting for that day. The warmer it is outside, the earlier it will shift into Night.
- The Early Shutdown time is adjusted using the Morning Boost Adjustment Curve but works in the opposite fashion. The warmer it is outside, the earlier the MPCQ Platinum will shift to night. As it gets colder, the time between early shutdown and the last Night setting diminishes. The maximum amount of Early Shutdown is 90 minutes.

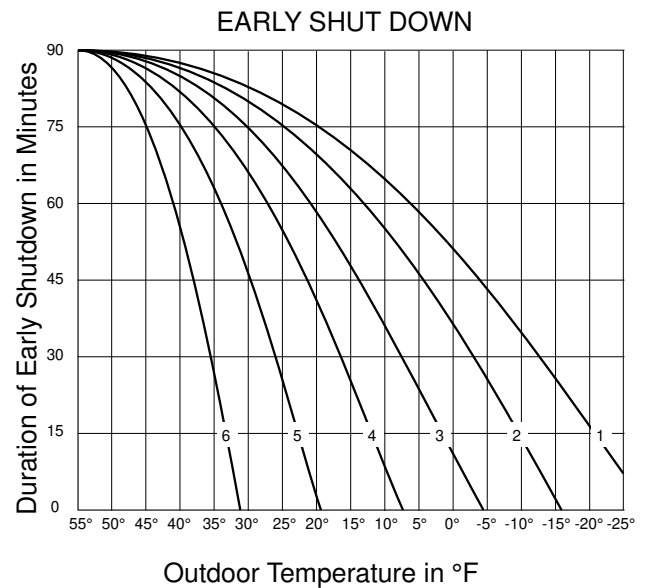

Stage Settings

SELECT: *Settings/System Settings/More Settings/Stage Settings*

The Stage Settings is for adjusting how the burners and their stages should respond to different operation steps. The Stages behave differently based on the selected Control Logic (see Startup Settings on page 17).

Cycle or PID

- Reaction Time
- Purge Delay
- Minimum Run Time (page 24)
- Standby Delay (page 24)
- Last Stage Hold (page 24)
- Lead Boiler (page 25)
- Rotate Mode (page 25)

Oversize (OSS)

- Throttle (page 24)
- Lead Boiler (page 25)
- Rotate Mode (page 25)

Reaction Time

(Available with PID Control Logic Only)

Adjustable from 1 minute to 10 minutes

Default: 2 minutes

SELECT *Settings/System Settings/More Settings/Stage Settings/Reaction Time*

- It is the amount of time it takes a single stage to affect the system.
- After the MPCQ Platinum turns on a stage trying to meet a set point, it will not turn on another stage until the reaction time has elapsed. Then, if a stage is needed, it will be energized.
- To determine the optimum time, start with a hot system in mild weather. Then, turn on a single stage and calculate how long it takes until the system begins to respond to that stage. That period should be set as the Reaction Time.

Purge Delay

(Available with PID Control Logic Only)

Adjustable from 0.0 minute to 10.0 minutes

Default: 0 minutes

SELECT *Settings/System Settings/More Settings/Stage Settings/Purge Delay*

- Most boilers must go through a purge cycle before they are brought online.
- When the MPCQ Platinum activates a boiler (the lowest stage on a burner), it does not start to calculate its output until the Purge Delay is over. This ensures that the unit can fully come online and is capable of producing output.
- The Purge Delay helps prevent short cycling of a newly activated burner. Once the lowest burner stage is activated, it **MUST** run through the entire Purge Delay period. The Reaction Time for that stage will start after the elapse of the Purge Delay.
- The minimum Purge Delay setting **MUST** be set to the time required by the boiler's manufacturer.

```

-- STAGE SETTINGS --
▶ Reaction Time 2m
Purge Delay 0.0m
Min Runtime 2m
Standby Delay 10m
Lst Stg Hold 0.0psi
<Lead Settings>

```

```

-- LEAD SETTINGS --
▶ Lead Boiler AB
Rotate Mode Time

```

```

-- REACTION TIME --
2m
[■■■■]

```

```

-- PURGE DELAY --
0.0m
[■]

```

Minimum Run Time

(Available with PID Control Logic Only)

Adjustable from 1 minute to 60 minutes

Default: 2 minutes

SELECT *Settings/System Settings/More Settings/Stage Settings/Min Runtime*

- It is the minimum amount of time any stage will run. It reduces short cycling.
- For the lowest stage on a burner, the Minimum Run Time starts after the purge delay.
- In addition to the Minimum Run Time, the Last Stage Hold applies to the last stage online.
- Initially, set the Minimum Run Time to half the Reaction Time.
- If System tends to overshoot, reduce the Minimum Run Time. If boilers tends to short cycle, increase Minimum Run Time.



Standby Delay

(Available with PID Control Logic Only)

Adjustable from 1 minute to 60 minutes

Default: 10 minutes

SELECT *Settings/System Settings/More Settings/Stage Settings/Standby Delay*

- The Standby Delay time only applies to boilers in Standby Mode.
- A Standby Boiler can only be activated after all the boilers in Auto Mode have run at high fire for the full Standby Delay.
- Standby boilers are usually used for backup or extreme load conditions. A Standby boiler can never be a Lead Boiler
- The full Standby Delay must always elapse regardless of what happens the system pressure. Therefore, a shorter Standby Delay will result in smoother set point operation in extreme conditions. Longer Standby Delay may prevent a standby boiler from firing if the other boilers can eventually meet the load or if the load decreases.
- When setting Standby Delay, remember that it will be added to the Reaction Time for the first stage on the first Standby boiler. The following stages start time will rely on the Purge Delay and Reaction Time only.



Last Stage Hold

(Available with PID Control Logic Only)

Adjustable from 0°F to 30°F

Default: 5°F

SELECT *Settings/System Settings/More Settings/Stage Settings/Lst Stage Hold*

- The Last Stage Hold prevents short cycling of the Lead Stage during low load conditions.
- In low load conditions, the system might have a load that is significantly less than the output of one Stage. When the MPCQ Platinum brings on the Lead Stage, the Set Point is quickly exceeded and the MPCQ Platinum turns the Lead Stage off.
- To prolong the run time during this type of condition, use the Last Stage Hold setting. The MPCQ Platinum will allow the system pressure to exceed the Set Point by the Last Stage Hold value before the Lead Stage is turned off.
- For example; with a Set Point of 10 Psi and a Last Stage Hold setting of 2 Psi, the Lead Stage boiler will remain on until the Set Point reaches 12 Psi then de-energize.

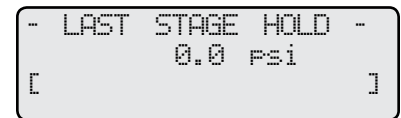

Avoiding Conflicting Boiler Limits

The pressure limits set on the boilers MUST be set considerably higher than the MPCQ Platinum's Set Point for the reasons detailed below.

- The System sensor is located on the common header some distance from the boilers.
- As the pressure rises in the header and before reaching the sensor location, energy is dissipated and due to steam characteristics and steam pipe length, pressure drops. Therefore, the pressure in the header will be lower than that registered by the boilers.
- In addition to the normal drop experienced between the boiler pressure and that read by the MPCQ Platinum sensor, the Last Stage Hold setting must be accounted for. The boiler limit must be set above the Set Point PLUS the Last Stage Hold PLUS the normal drop experienced in the piping.
- Using the previous example of a 2 Psi Last Stage Hold with a 10 Psi Set Point, the boilers' limits must be set enough over 12 Psi to prevent the boilers' internal limits from being reached. In this situation, the boiler high limit should be set at approximately 14 Psi.

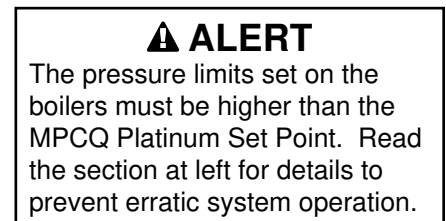

Throttle

(Available with OSS Control Logic Only)

Adjustable from 0.5 Psi to 5.0 Psi

Default: 1.0 Psi

SELECT *Settings/System Settings/More Settings/Stage Settings/Throttle*

- The Throttling sets a pressure band around the Set Point that controls when stages will be turned on or off.
- For example, in the Oversize (OSS) Control Logic, no stages will be activated until the pressure falls one full Throttle below the Set Point. A second stage will be activated when the pressure falls to two full Throttles below the Set Point, and so on, with one extra stage being turned on for every Throttle below the Set Point the System pressure reaches.
- Stages will be turned off as the pressure rises toward the Set Point with one full Throttle as a difference.
- The last stage to be turned off will be allowed to exceed the Set Point by a full Throttle before it is turned off. This helps prevent the last stage from short cycling when the load is low or when the stage is oversized.

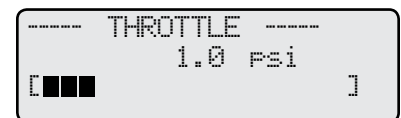

Set Point = 12 Psi Throttle = 2 Psi Boilers (A, B, C, D, E, and F) Lead Stage =<A>

System Pressure	Throttle Ranges	Falling Pressure		Rising pressure	
		Stages Turned On	Stages On	Stages Turned Off	Stages On
14 Psi	-1	----	None	A	None
12 Psi	0	----	None	----	A
10 Psi	1	A	A	B	A
8 Psi	2	B	A + B	C	A + B
6 Psi	3	C	A + B +C	D	A + B +C
4 Psi	4	D	A + B +C + D	E	A + B +C + D
2 Psi	5	E	A + B +C + D + E	F	A + B +C + D + E
0 Psi	6	F	A + B +C + D + E + F	----	A + B +C + D + E + F

Lead Boiler and Rotation Settings

Lead Boiler

Adjustable to Any Auto Configured Boiler

Default: <A>

SELECT *Settings/System Setting/More Setting/Stage Setting/Lead Boiler*

SELECT *Settings/System Setting/More Setting/Stage Setting/Lead Settings/Lead Boiler*

- The Lead Boiler’s lowest firing stage will always be the first stage brought on when there is a call for output. As more output is needed, additional stages are added.
- The Lead Boiler is shown on the main display in brackets. The letters in brackets will indicate the stages controlled by the boiler.
- In a 2-Stage system (see Boiler Type on page xx), the display will show the two Lead Boiler stages bracketed <AB>. In a 3-Stage system, the display will show the three Lead Boiler stages bracketed <ABC>, and so on.
- The Lead Boiler can be rotated based on the Rotation Mode selected. (See next setting)

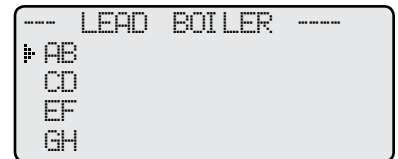

Rotate Mode

Time (1 - 999hrs), Manual, First-On/First-Off (FOFO)

Default: Time(24hrs)

SELECT *Setting/System Setting/More Setting/Stage Setting/Rotate Mode*

SELECT *Setting/System Setting/More Setting/Stage Setting/Lead Setting/Rotate Mode*

- Automatically rotating the Lead Boiler among the active boilers promotes more even wear on the boilers and can help prolong their life.
- On power up, or any time the MPCQ Platinum loses power, the Lead Boiler will be the lowest Boiler in Auto Mode (A).
- The MPCQ Platinum has three Lead Boiler rotation options.

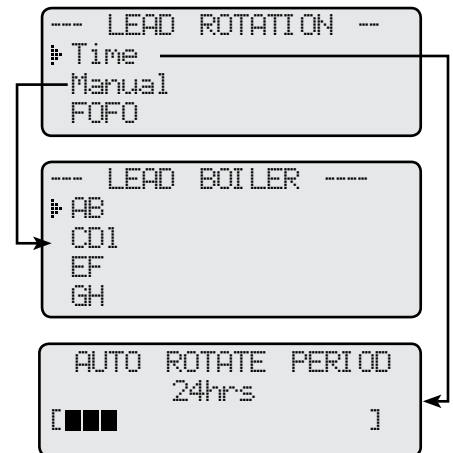

Time

- If the default 24 hour rotation is used, at 2 am every morning the Lead Boiler will change to the next Boiler in Auto Mode.
- Note: If the system time is not set, the MPCQ Platinum will assume it was installed at 2 PM. Thus, rotating the first time after 12 hours, followed by every 24 hours.
- If the Rotate Time (Auto Rotate Period) is changed, the Lead Boiler will change to the next Boiler in Auto Mode every time the Rotate Time (Auto Rotate Period) has elapsed. For example, with a 48 hour Rotate Time, the Lead Boiler will rotate from A to B after the first 48 hours of operation, and then from B to C after the next 48 hours, and so on.
- When less output is needed, the additional boiler stages are turned off in the reverse order of how they were added. For instance, if the boiler stages were added in the sequence A, B, and C, then they will be turned off in the sequence C, B, and A.
- After selecting the Time rotation option, you'll need to select the Auto Rotation Time Period from the next screen.

Manual

- If Manual is selected, the Lead Boiler will not automatically rotate.
- In Manual, whichever Boiler is presently the Lead will remain the Lead until there is a power failure. Then the MPCQ Platinum will revert to the lowest Boiler in Auto Mode.

First-On/First-Off (FOFO)

(AVAILABLE IN PID CONTROL MODE ONLY)

- If First-On/First-Off (FOFO) is selected, the concept will follow this example; if A is the lead, the starting sequence of boilers will be A, B, then C. When the de-energizing of the stages starts, it will turn off A, B, Then C. Then, stage D will be the new lead for the next load.

Boiler Operation Mode

Auto, Standby, Off, On

Default: Auto

BOILER (Button)

By pressing the *BOILER* button, the Boiler Operation mode menu selection will display. There are four modes. By pressing the *BOILER*, *NEXT*, or *PREV* buttons the display will scroll between the different modes.



- **Auto** - In this mode boiler stage will operate based on control settings. Boiler can be used in rotation. The status will read:
 - --- (All stages are Off)
 - **LOW** (Only lowest firing stage on a multi-stage boiler is On)
 - **MED** (Both Low and Medium firing stages on a 3-stage boiler are On)
 - **MLOW** (Both Low and Medium Low firing stages on a 4-stage boiler are On)
 - **MHIGH** (The three lowest firing stages on a 4-stage boiler are On)
 - **HI** (The On/Off boiler stage is On)
 - **HIGH** (All firing stages on a multi-stage boiler are On)
- **Standby** - Boiler will start only after all Boilers set to Auto are on for the full Standby Delay. The display status will read **STB**.
- **Off** - Boiler relay will be Off until this setting is changed. The display status will read **OFF**.
- **On** - Boiler relay as well as System relay will be On until this setting is changed. The display status will read **ON**.
- The following are the possible stage status:
 - **C/E** - Will only occur to a boiler wired to an extension and the Extension communication has terminated.
 - **L/O** - The boiler is in lockout due to lockout input is shorted on the Extension.

Schedules

SELECT *Setting//Schedules*

- The MPCQ Platinum has two levels of heat. The Day Time level is used when a building is occupied and people are active.
- The Night Time (Setback) level is used when a building is not occupied, or when people are sleeping.
- The MPCQ Platinum can have up to four Day Time and four Night Time (Save) periods for each individual day of the week. The MPCQ Platinum will show which period is being edited on the 2nd line of the display.
- Every time the MPCQ Platinum updates the clock time, it checks the Day/Night program. If there is a matching Day/Night time programmed, it sets the heat level accordingly, otherwise, the heat level is not changed.
- If an office building is unoccupied all weekend, simply set the last Night setting (8:00 PM on Friday). Then, set all the Saturday and Sunday programs to **:*** (using the DEL button). The control will stay in Night Time (Save) until it reaches a Day setting (6:00AM on Monday).

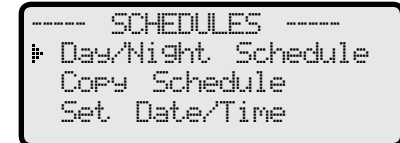

▲ ALERT

The MPCQ Platinum will ignore any Time setting that reads **:***.

The Day #1 setting for any Day Time is used by the Boost. The last Night Time setting is used by the Early Shutdown ESD.

Day/Night Schedule

Day#1, Day#2, Day#3, and Day#4

Day #1 default: 6:00 am

Night#1, Night#2, Night#3, and Night#4

Night #1 default: 10:00 PM

SELECT: *Settings/Schedules/Day Night Schedule*

- Use this setting to set up to 4 Day Time and 4 Night Time (Save) settings per each day of the week. The Day Time settings allows the MPCQ Platinum to cycle based on the Day Outdoor Cutoff, Day Heat Adjustment, and Day Space Target (when Cycle is selected as the Operation Mode) or based on the Set point and Day Outdoor Cutoff (when Set Point is selected as a Operation Mode). See Operation Mode on page 17.

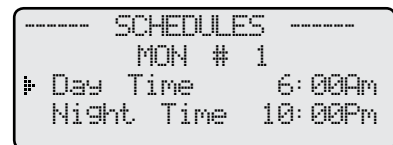

- If Manual Boost feature is being used, it uses the Day #1 time on (1st setting of that day) as a Boost calculation starting point.
- If Vari-Boost feature is being used, it uses the Day #1 time on (1st setting of that day) as a Boost calculation ending point.
- The actual Boost start time varies depending on the Outdoor Temperature (OD) and Boost Adjustment. See page 22.
- The Night Time settings lets the MPCQ Platinum follow the cycle based on the Night Outdoor Cutoff, Night Heat Adjustment, and Night Space Target (when Cycle is selected as the Operation Mode). Furthermore, if the Early Shutdown feature is being set, it uses the last Night Time setting of that weekday as an Early Shutdown calculation ending point. In this case, the actual Early Shutdown start time will vary based on Outdoor temperature and Boost Adjustment. See page 22.
- In this area of the MPCQ Platinum control menu 3 buttons will take effect. The NEXT button will allow the scroll between the 4 different settings of a specific weekday. The BOILER/DAY button will allow the scroll between all weekdays. The PREV/DEL button will erase the Day Time and Night Time settings for a specific day schedule.
- When setting the date and time over the Internet, type each time value in a (hh:mm AM) format. Then, press the Enter on your keyboard after each field.

Schedule Example

Day/Night Schedule

User must click <Enter> after typing in new time to save into schedule

		MON	TUES	WED	THURS	FRI	SAT	SUN
1	Day	6:00 AM	6:00 AM	6:00 AM	6:00 AM	7:00 AM		
	Night	10:00 PM ^{♦♦}	10:00 PM ^{♦♦}	10:00 PM ^{♦♦}	10:00 PM ^{♦♦}	11:00 AM		
2	Day					1:00 PM	8:00 AM [♦]	
	Night					4:00 PM	4:00 PM ^{♦♦}	
3	Day					6:00 PM		
	Night					10:00 PM ^{♦♦}		
4	Day							
	Night							

Copy Monday To All Week

- ♦ No boost will take effect.
- ♦♦ Early Shut Down ends. Night Schedule begins

Weekday	Cycle	Set Point
Monday through Thursday	<ul style="list-style-type: none"> Vari-Boost begins before 6 AM and ends at 6 AM[♦] Day Cutoff, Day Heat Adjustment, and Day Space Target are maintained from 6 AM until before 10 PM Early Shutdown starts before 10 PM and ends at 10 PM Night Cutoff, Night Heat Adjustment, and Night Space Target are maintained from 10 PM until the Vari Boost of the following morning 	<ul style="list-style-type: none"> No Boost will take effect Day Cutoff and Set Point are maintained from 6 AM until before 10 PM No Early Shutdown will take effect Night Cutoff and Set Point less Setback are maintained from 10 PM until before 6 AM of the following morning
Friday	<ul style="list-style-type: none"> Vari-Boost begins before 7 AM and ends at 7 AM[♦] Day Cutoff, Day Heat Adjustment, and Day Space Target are maintained from 7 AM until before 11 AM Night Cutoff, Night Heat Adjustment, and Night Space Target are maintained from 11 AM until before 1 PM Day Cutoff, Day Heat Adjustment, and Day Space Target are maintained from 1 PM until before 4 PM Night Cutoff, Night Heat Adjustment, and Night Space Target are maintained from 4 PM until before 6 PM Day Cutoff, Day Heat Adjustment, and Day Space Target are maintained from 6 PM until before 10 PM Early Shutdown starts before 10 PM and ends at 10 PM Night Cutoff, Night Heat Adjustment, and Night Space Target are maintained from 10 PM until before 8 AM of the following morning 	<ul style="list-style-type: none"> No Boost will take effect Day Cutoff and Set Point are maintained from 7 AM until before 11 AM Night Cutoff and Set Point less Setback are maintained from 11 AM until before 1 PM Day Cutoff and Set Point are maintained from 1 PM until before 4 PM Night Cutoff and Set Point less Setback are maintained from 4 PM until before 6 PM Day Cutoff and Set Point are maintained from 6 PM until before 10 PM No Early Shutdown will take effect Night Cutoff and Set Point less Setback are maintained from 10 PM until before 8 AM of the following morning

Weekday	Cycle	Set Point
Saturday	<ul style="list-style-type: none"> No Vari-Boost as the Day #1 is not programmed Day Cutoff, Day Heat Adjustment, and Day Space Target are maintained from 8 AM until before 4 PM Early Shutdown starts before 4 PM and ends at 4 PM Night Cutoff, Night Heat Adjustment, and Night Space Target are maintained from 4 PM until before 6 AM Monday morning 	<ul style="list-style-type: none"> No Boost will take effect Day Cutoff and Set Point are maintained from 8 AM until before 4 PM No Early Shutdown will take effect Night Cutoff and Set Point less Setback are maintained from 4 PM until before 6 AM Monday morning
Sunday	<ul style="list-style-type: none"> Night Cutoff, Night Heat Adjustment, and Night Space Target are maintained all Sunday until before 6 PM 	<ul style="list-style-type: none"> Night Cutoff and Set Point less Setback are maintained all Sunday until before 6 AM Monday morning

- ◆ If no space sensors with space average are available the Vari-Boost will end at the Day #1 time setting. However, if space sensors with space average are available and Space Lock was enabled, the Vari-Boost can extend up to 1 hour past the Day #1 setting.

⚠ ALERT

When working with MPCQ Platinum Internet communication with Space Lock enabled, the Boost can extend to an additional hour past the Day #1 setting if Day Space Target was not reached within the Boost period.

Copy Schedule

SELECT: *Settings/Schedules/Copy Schedule*

- To reduce the need for setting each weekday time schedule, this feature has been made to allow the copying of the Monday schedule settings to the rest of the week.

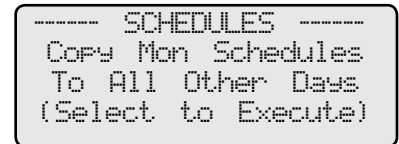

Set Date and Time

SELECT: *Settings/Schedules/Set Date & Time*

- The Date and Time will need to be set in the startup process of the MPCQ Platinum.
- Selecting Date will allow you to set the year followed by the month then finally the day.
- Adjust the time by selecting Time from the menu and then scrolling through the hours followed by the minutes.
- Pay attention to the AM/PM when adjusting the hours.
- Internet controls will receive their date and time based on their Internet configured building time zone automatically.



⚠ ALERT

Remember that the battery is the only backup for the Date and Time. If no power is supplied to the MPCQ Platinum and there was no battery or battery had no power, date and time values will be lost and will need to be re-entered.

Vacation Schedule Setting

(Available with RINet (Internet Communication Controls Only))

- The vacation Space Target and settings can only be set on the Internet ICMS website.
- The MPCQ Platinum offers a Vacation Schedule which provide the user with an adjustable lower space target that can be maintained between two specified date/time periods. See Vacation Schedule on page 33.



Maintenance

SELECT: *Settings/Maintenance*

The Maintenance menu gives access to sensor trimmings, Fast Cycle, Heat Establish Pressure, and the Password protection.

System and Outdoor Sensor Trim

(Pressure) Adjustable from -3.0 to +3.0

Default: 0.0

(Outdoor) Adjustable from -5 to +5

Default: 0

SELECT: *Settings/Maintenance/Pressure Trim*

SELECT: *Settings/Maintenance/Outdoor Trim*

- The Heat-Timer pressure transducer and thermistor type sensors are very accurate, and normally require no calibration. However, sometimes it may be desirable to make small adjustments to the displayed value for either the Outdoor temperature (OD) or the System pressure (SYS) to match other gauges or sensors on the same system. The Trim setting can be used to adjust the displayed value.
- Do not use the Trim setting to make the Outdoor temperature sensor match that reported on the radio or TV. Outdoor temperature can vary widely over a broadcast range. Only trim the outdoor sensor based on an accurate thermometer reading taken where the sensor is located.

Fast Cycle

(Available in Cycle Operating Mode Only)

On, Off

Default: Off

SELECT: *Settings/Maintenance/Fast Cycle*

- The Fast Cycle changes cycle minutes to cycle seconds, so a 60 minute cycle can be reviewed in 60 seconds.
- The Fast Cycle is primarily used to test the MPCQ Platinum cycle operation. If the control is in the OFF part of a cycle, selecting Fast Cycle = On, will allow the remaining cycle to be completed in less than a minute. At that point, the MPCQ Platinum will not sequence start another cycle until the Heat is Established.
- Note the Fast Cycle feature only works when the MPCQ Platinum is in a cycle. It cannot be used to override the Heat Established function or to prevent the Pressure Lockout.

Heat Establish Pressure and Pressure Lockout

(Available in Cycle Operating Mode Only)

Adjustable from 0.5 psi to 5.0 psi

Default: 0.5 psi

SELECT: *Settings/Maintenance/Heat Est Pressure*

- The Pressure Lockout prevents another cycle from starting when the heating system is still hot. Any pressure at or above the Heat Establish Pressure will indicate a Pressure Lockout.
- Having the system pressure at or above this setting indicates that the building steam pressure is high enough to provide heat and no stage should start until the steam pressure has dropped. See Cycle Operation Concept on page 4.

Password and Local Security

Adjustable to any four letters

Default: MPCQ

SELECT: *Settings/Maintenance/Password*

- The Password is used as a security measure to prevent unauthorized local control users from making changes to the MPCQ Platinum settings.
- It will not protect against any remote changes. Remote changes have a web login screen with a different password for each user.
- Setting up the Password feature makes servicing more difficult and can disable the system if management or ownership should change.
- The Password feature is not active unless a user enables it. If you choose to enable the Password, DO NOT forget the Password. Write it down and store it in a safe location known to at least one other authorized user.
- When the Password is enabled, none of the settings, except Shift to Extend Day, Auto/Bypass toggle switch, and Schedules can be changed without entering the Password.

```

- MAINTENANCE MENU-
# Pressure Trim 0.0psi
Outdoor Trim    +0°F
Fast Cycle      Off
Ht-Est-Press    0.5psi
Password
  
```

```

-- PRESSURE TRIM --
          0.0psi
[■■■■■■]
  
```

```

-- OUTDOOR TRIM --
          +0°F
[■■■■■■]
  
```

```

-- FAST CYCLE --
# Off
  On
  
```

```

-HEAT EST PRESSURE -
          0.5psi
[■]
  
```

```

PASSWORDS ENABLED?
# No
  Yes
  
```

```

----- LOGIN -----
Enter Password:
  xxxx
  
```

```

Change PASSWORD?
# No
  Yes
  
```

- When a change is to be made at a protected control, a login screen will show upon trying to a setting. To enter the Password, turn the ADJUST/SELECT knob until the desired letter is shown. Then, press the ADJUST/SELECT to move on to the next letter.
- Once the Password is entered, you can make multiple changes. The Password will expire 5 minutes after the last change has been made.
- To enable or change the Password, enter the Maintenance menu and select Password. Then, follow the prompts to enable or change the Password.
- To allow an Internet communication control overridden values to be adjusted locally, the Panel Password Mode under the Maintenance screen must be set to either "Only Overrides Require Password" or "All Changes Require Password". This will allow a control user with the proper password to make changes to overridden settings.

⚠ ALERT
 When password is enabled, all settings will be read only except for the Shift to Extend Day and the Auto/Bypass switch operation.

⚠ WARNING
 Any setting that is changed remotely will automatically be set to override. An overridden setting is not adjustable unless "ONLY OVERRIDES REQUIRES PASSWORD" or "ALL CHANGES REQUIRE PASSWORD" has been selected from the Internet Maintenance screen.

**Override Remote Changes
 (Requires a Communication Package)**

- With remote communication, any setting that is changed remotely will automatically be set to override. An overridden setting will have a star next to its value on the control display (The screen shows the System Run-On with as an overridden value). In addition, it will not be modifiable unless the password is entered.
- Internet controls offers the capability of taking a specific value out of its override status. Just go to the ICMS System Override webpage and click the button to the right of that setting.
- To take all settings out of override, go the ICMS System Overrides webpage and select "Remove all Overrides" button.
- To allow an Internet communication control overridden values to be adjusted locally, the Panel Password Mode under the Maintenance live session must be set to either "Only Overrides Require Password" or "All Changes Require Password". This will allow a control user with the proper password to make changes to overridden settings.
- All BACnet IP communication controls provide access to change their override values locally when the password is entered.

```

SYSTEM SETTINGS 2
▶ System Run-On 2n*
Setback 2.0psi
<Stage Settings>
<Remote Interface>
    
```

System Overrides		
Description:	Panel Settings:	Override Settings:
Boost Mode	Vari	Vari
Bypass Mode	Auto	Auto
Day Extension Time	90	90
Day Heat Adjustment	E	E
Day Space Target	71	68

Panel Password Mode

ONLY Overrides Require Password | ALL Changes Require Password | Password: MPCQ

Overrides Protected | Panel Changes, EXCEPT Overrides, Require Password

User must click <Enter> after typing in password (4 chars) to save.

Shift

Day, Night, Extended Day, Schedule
 Extend Day (60 to 240 minutes)

Default: Schedule
 Default: 90 minutes

SELECT: Settings/Shift

SELECT: Settings/Shift/Extend Day

- The Shift selection allows you to manually shift from any setting into Night, Day, Extended Day Schedule, or programmed Schedules. This can be used to temporarily override the programmed schedule.
- A typical example where the shift would be used is in a school where an event has gone into overtime. Instead of re-programming the control to keep it from going into the Night mode, simply select the Shift to Extend Day.
- The amount of time the MPCQ Platinum will hold the shift is based on the following:
 - **Shifting from Day to Night**

```

SHIFT FROM DAY TO
▶ Night
Day
Extend Day
Schedule
    
```

```

- EXTEND DAY TIME-
  90 Min
[■■■■■]
    
```

The control will stay in the Night mode until the start of the next programmed Day mode time. The Display will show NIT SHT to indicate this status.

The control will stay in the Day mode until the start of the next programmed Night mode time. The Display will show DAY SHT to indicate this status.

- **Shifting to Extended Day**

The control will stay in the Day mode for an adjustable amount of time (adjustable between 60 to 240 minutes), and then revert automatically back to the scheduled program. This prevents a user (without a programming password) from shifting the MPCQ Platinum to Day mode for an extended period of time when it is scheduled as Night. When the control is manually shifted to Extended Day, the Display will alternate between the DAY EXT and the Extended Time balance remaining in minutes indicating the Extended Day mode.

- The Shift to Extended Day option will be available to anyone to change. Password protection will not affect this option.

Auto/Bypass

Auto

Default: ± 0.0

- The Bypass switch offers the user the capability of bypassing the control operation and allowing the stages and system relays to run using their own operating limits.
- Therefore, if there is no heat, test the system and the boilers by switching the control to bypass. If the units do not run, the problem is not with the MPCQ Platinum control.
- When the switch is in the bypass position, no automated functions will be executed. That means, sensor fault, shutdown, and prove will have no effect on the System and stage relays. All System and stage relays will energize regardless of their Stage mode. The display will change to read the total time the control has been in Bypass and all stage status will display **EYP**.
- The switch must be in the AUTO position for the MPCQ Platinum to control the system and stage relays.
- This switch will not be affected by any password setting.
- If the control was set to Bypass locally, remote operation of the Bypass will not function.
- If the control was set to Bypass remotely, then only remotely can the control be removed from Bypass operation.



▲ ALERT

When the MPCQ Platinum is switched to Bypass locally or remotely, all stages will turn on regardless of the Boiler Mode setting. In this case, Sensor Fault, Shutdown, and Prove will have no effect on the control operation.

```

OD= 43F   SYS=8.2Psi
BYPASS: 00 1H 3M
<AB>   CD   EF   GH
BYP   BYP   BYP   BYP

```

Communication

- The MPCQ Platinum is available as a stand alone or with one of the communication options. Each of the communication options requires the purchase of the control with that specific remote communication option or the upgrade of the control.
- An Internet communication option (MPCQ Platinum RINet) provides the user with access to modify control settings, add space sensors and other sensors, e-mail alarms and reports, view history, and much more.
- A BACnet communication option (MPCQ Platinum BAC) provides the user with the capability of changing settings and communicating over a BACnet IP network. The same control can be used with Fieldserver and other gateways to communicate over a multitude of protocols. Contact Heat-Timer to find out about the possibility of interfacing to other protocols.

Remote Interface

SELECT *Settings/System Settings/More Settings/Remote Interface*

- The MPCQ Platinum can be controlled remotely through the Internet or a BACnet network. The Internet communication is started by creating an account using the Heat-Timer Internet Control Management System (ICMS) website (<http://www.htcontrols.com>). After the account is approved, the user can create the building where the control will reside. Then when the control communicates, he can assign the control to the building. Visit the ICMS website for additional help information.
- Several features are only available to Internet controls including: Configuring additional sensors (Space, Temperature, Oil level, Stack temperature, pulse/count sensor (for water meters), , vacuum, humidity, and pressure), Space feedback, Vacation schedule, Alarm activation and deliveries, history analysis and reporting, Data Export to a variety of spreadsheets and databases.

```
- REMOTE INTERFACE -
# Space Lock      On
Day Target       75F
Night Target     65F
Internet ID      Solo
<Network Settings>
```

Space Lock

(Requires RINet Package and Space Sensors)

On or Off

Default: Off

SELECT *Settings/System Settings/More Settings/Remote Interface/Space Lockout*

- The Space lockout is a major energy saving feature that disables the MPCQ Platinum from starting another heating cycle when the space average is at or exceeds the Day or Night Space targets.
- The Space Lockout is required to be set to On to be able to use Space sensors for Day Target and Night Target. This option can be set when the MPCQ Platinum has the Internet communication packages.
- At least one space sensor with Space Average activated must be configured through the Internet to utilize the Space Lock. However, Heat-Timer recommends a minimum of four sensors but should have approximately one sensor in 10% of the total units..

```
- SPACE LOCKOUT -
# Off
On
```

Day Target

(Requires RINet Package and Space Sensors)

Adjustable from 55°F to 85°F

Default: 75°F

SELECT *Settings/System Settings/More Settings/Remote Interface/Day Target*

- For the Day Target to be used, Space Lock must be enabled.
- The Day Target is the space temperature the MPCQ Platinum will try to reach during the Boost period (Day #1 setting) when coming out of the Night Time setting.
- During the Day schedule, the MPCQ Platinum will check the Space Average temperature before starting a new heating cycle. If it was below the Day Target, the MPCQ Platinum will start another heating cycle. Otherwise, the control will go into Space Lockout and no other heating cycles will start unless the Space Average drops below the Day Target.

```
----- DAY TARGET -----
              75°F
[■■■■■■■]
```

Night Target

(Requires RINet Package and Space Sensors)

Adjustable from 50°F to 80°F

Default: 65°F

SELECT *Settings/System Settings/More Settings/Remote Interface/Night Target*

- For the Nighty Target to be used, Space Lock must be enabled.
- The Night Target is the space temperature the MPCQ Platinum will try to reach during the Early Shutdown ESD period when switching from the Day setting.
- During the Night schedule, the MPCQ Platinum will check the Space Average temperature before starting a new heating cycle. If it was below the Night Target, the MPCQ Platinum will start another heating cycle. Otherwise, the control will go into Space Lockout and no other heating cycle will start unless the space average drops below the Day Target.
- If Boost with ESD was enabled, during the Early Shutdown while the space average is above the Night Target, the control will be in Fast Cool Down where it will not start another cycle until the Space Average temperature drops below the Night Target.

```
----- NIGHT TARGET -----
              65°F
[■■■■■]
```

Vacation Schedule

(Requires RINet Package and Space Sensors)

Adjustable from 43°F to 58°F

Default: 45°F

Adjustable only through the Internet ICMS website

- The MPCQ Platinum offers a Vacation Schedule, which provides the user with an adjustable lower space target that can be maintained between two specified date/time periods.
- This is useful for schools and office buildings to be used during holidays and vacations.
- After the vacation end time, the control will switch to boost until the Day Target is reached or three hours, whichever comes sooner.

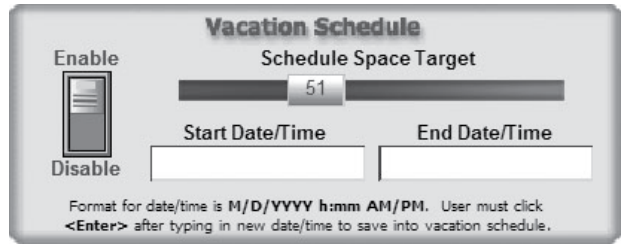

Internet Communication

Visit (<http://www.htcontrols.com>)

(Requires Internet Package)

- The MPCQ Platinum can be set to communicate over the Internet.

Internet ID

(Requires RINet Package)

Solo, 1-32, Custom

Default: Solo

SELECT Settings/System Settings/More Settings/Remote Interface/Internet ID

- If the control is connected directly to the Internet using a dynamic cable modem without a firewall, then the user must select Solo as the Internet ID. The MPCQ Platinum will acquire its Internet information directly from the cable modem.
- If the control is behind an Internet router or a server with an active DHCP server, the firewall must be configured for port forwarding. (See Internet Port Forwarding Table.) In addition, the MPCQ Platinum must have its Internet ID set to any number between 1 and 32. The DHCP server must not provide an internet IP that matches the control local static IP. (See Internet Port Forwarding Table.)
- The Custom option is primarily used when the Internet connection on the WAN side is Static or when the DHCP server is not activated. Thus, allows the user to manually configure the Internet connection by entering the IP, Mask, Gateway, and DNS information. All the information must be entered in an IP format.
- On a power up, the MPCQ Platinum will have a delayed Internet start (approximately one to two minutes) to allow routers, modems, and servers to initialize and get online.



ALERT
When connecting multiple panels to the Internet, a Heat-Timer Internet Router is required.

ALERT
If the MPCQ Platinum is behind a firewall, make sure that outgoing port 4133 is open.



Internet Port forwarding Table

Internet ID	Actual IP	Port to Forward
Solo	N/A	8082
1	---.---.---.101	8082
2	---.---.---.102	8083
3	---.---.---.103	8084
4	---.---.---.104	8085
5	---.---.---.105	8086
6	---.---.---.106	8087
7	---.---.---.107	8088
8 - 31	---.---.---.108 to ---.---.---.131	8089 to 8112
32	---.---.---.132	8113
Custom	Any IP	8082

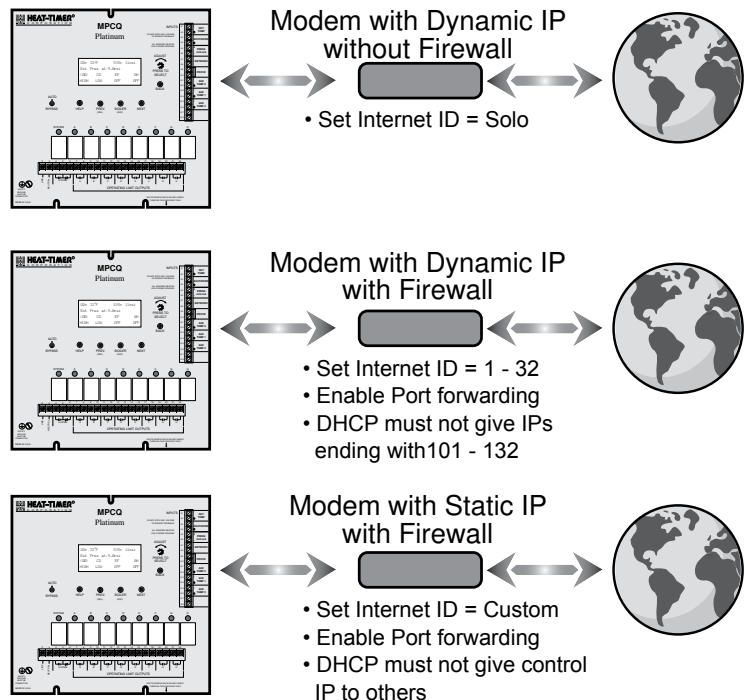

Internet Alarms

- The MPCQ Platinum RINet has a set of pre-configured control alarms that can be activated through the Internet ICMS website by visiting the control Alarms webpage.
- Each alarm can be activated by creating at least one delivery. Simply, click on the *Alarm* button. Then, add a delivery by clicking on the *Add Delivery* button on the right hand side of the screen. A delivery method option (Web or e-mail) must be selected from the drop down list. Then, fill the fields with the delivery information including subject, e-mail, and message.
- A delivery can be in the form of a web alarm (the building and control icons will have a Red dot), e-mail alarm, a text message to a cell phone (it is an e-mail in the form of 111111111@CellCompany.com where CellCompany.com will vary with the cell phone carrier).
- The MPCQ Platinum control alarms are:
 - (#1000) In Bypass for Over 1 Hour: This alarm will generate if the control has been put into Bypass either locally (Auto/bypass switch. See page 31.) or remotely for a full continuous hour.
(#6000) Is an end alarm that can be set to indicate that the initial alarm status has terminated.
 - (#1002)/(#1003) Space Temp Exceeds/Below Target by More Than 10°: This alarm will be sent only if the space average over the past two hours has averaged 10°F above or below the space target.
(#6002)/(#6003) Is an end alarm that can be set to indicate that the initial alarm status has terminated.
 - (#1004) Extension Module Communications Error: This alarm will be generated if the extension panel communication the MPCQ Platinum has terminated.
(#6004) Is an end alarm that can be set to indicate that the initial alarm status has terminated.
 - (#1005) Lockout on Boiler: This alarm will be generated for any boiler that has gone into lockout status. The message will indicate the specific boiler in lockout.
(#6005) Is an end alarm that can be set to indicate that the initial alarm status has terminated.
 - (#1006) System Pressure Fault: This alarm will be generated whenever the System sensor goes open or short.
(#6006) Is an end alarm that can be set to indicate that the initial alarm status has terminated.
 - (#1008) No prove for More Than 10 Minutes: This alarm will be generated whenever there is a call for output but the Prove terminals have not been shorted for over 10 minutes..
(#6008) Is an end alarm that can be set to indicate that the initial alarm status has terminated.



BACnet Communication

(Requires BAC Package)

- The MPCQ platinum BAC is designed to communicate over a BACnet IP network.
- If the MPCQ Platinum was purchased with a BACnet communication package, some of the following settings must be configured to guarantee proper communication.

BACnet Communication Option

SELECT: MENU/<System Settings>/<more Settings>/Remote Interface/Network Settings

- After connecting the MPCQ Platinum to the BACnet network, see Wiring the BACnet Communication on page 13, the user must set the following parameters according the BACnet Network Administrator's instructions.

```

--NETWORK SETTINGS--
BACnet ID:      0
IP:            ---.---.---.---
Msk:           ---.---.---.---
Gws:           ---.---.---.---
  
```

BACnet Device ID

- This is a unique ID within the BACnet network. It must be provided by the BACnet Network Administrator and entered into the BACnet ID field. The value must not be 0.

IP, Mask, and Gateway Address

- These fields are either left blank if the IP information is automatically provided by the network (DHCP server assigns IPs). Otherwise, fill in these information as per the Network Administrator instructions

⚠ ALERT

A MPCQ Platinum that is BACnet capable will display -- NETWORK PANEL -- on the 2nd row of the display when it is in screen saver mode.

MPCQ Platinum BACnet Variable List

The following is the BACnet variable list that can be used to communicate with the MPCQ Platinum.

OBJ ID	OBJECT NAME	DESCRIPTION	TYPE*	UOM	RANGE	READ ONLY
0	BOOSTADJ	Vari-Boost Adjustment	AV	none (95)	0.1 - 6.4	
100	BOOSTMODE	Boost Mode	MV		1=Disabled, 2=Manual, 3=Vari, 4=Vari+ESD	
200	BOOSTTIME	Manual Boost Time	AV	Minutes(72)	0 - 120	
300	BPTIME	Bypass Time	AV	Minutes(72)	0 - 2,147,483,647	X
400 through 431	BSTATUS	Boiler Status	MV		1=Off, 2=On1=Off, 2=Low, 3=High1=Off, 2=Low, 3=Med, 4=High1=Off, 2=Low, 3=MLow, 4=MHigh	X
500	BTYPE	Boiler Type	MV		1=On/Off, 2=2-Stage3=3-Stage, 4=4-Stage	
600	BYPASSMODE	Bypass Mode	BV		0=AUTO, 1=ON	
700	CLENGTH	Cycle Length	AV	Minutes(72)	10 - 240	
800 through 831	COMERR00 through COMERR31	Communication Error	BV		0="", 1=C/E	X
900	DADJUST	Day Heat Adjustment	MV		1=A, 2=B, 3=C, 4=D, 5=E, 6=F, 7=G, 8=H, 9=I, 10=J, 11=K, 12=L, 13=M, 14=N, 15=O, 16=P	
1000	DCUTOFF	Outdoor Day Cutoff	AV	°C(62), °F(64)	-6 - 38, 20 - 100	
1100	DLS	Day Light Saving	BV		0=Enable, 1=Disable	
1200	FAULTMODE	Sensor Fault Mode	BV		0=OutputOn, 1=OutputOff	
1300	INMODE	Sensor Mode	BV		0=°F, 1=°C	
1400	LEAD	Lead Boiler	MV		(Refer to Table 2)	
1500 through 1531	LOCK00 through LOCK31	Lockout Input	BV		0=(inactive), 1=L/O,	X
1600	LOGIC	Logic Mode	BV		0-PID	
1700	LSTHOLD	Last Stage Hold	AV	psi(56)	0 - 5 psi	

OBJ ID	OBJECT NAME	DESCRIPTION	TYPE*	UOM	RANGE	READ ONLY
1800	MINRUN	Min Runtime	AV	Minutes(72)	1-60	
1900 through 1931	MODE00 through MODE31	Boiler Mode	MV		1=Auto,2=Standby,3=Off,4=On	
2000	NBOILER	Total Boilers	AV		1 - 32/(BTYPE+1)	
2100	NADJUST	Night Heat Adjustment	MV		1=A, 2=B, 3=C, 4=D, 5=E, 6=F, 7=G, 8=H, 9=I, 10=J, 11=K, 12=L, 13=M, 14=N, 15=O, 16=P	
2200	NCUTOFF	Outdoor Night Cutoff	AV	°C(62), °F(64)	-6 - 38, 20 - 100	
2300	ODTEMP	Outdoor Sensor	AV	°C(62), °F(64)	-40 - +250	X
2400	ODTRIM	Outdoor Sensor Trim	AV	°C(62), °F(64)	-3 - +3, -5 - +5	
2500	OPMODE	Operation Mode	BV		0=Cycle, 1=Set Point	
2600	PDATE	Panel Date	AV	Days (70) since 1/1/1981	0 - 2,147,483,647	
2700	PRETRIM	Pressure Sensor Trim	AV	psi(56)	-3 - 3	
2800	PTIME	Panel Time	AV	Minutes(72) since 0:00	0 - 1439	
2900	PURGE	Purge Delay	AV	Minutes(72)	0-10	
3000	REACT	Reaction Time	AV	Minutes(72)	1 - 10	
3100	RTMODE	Lead Stage Rotation Mode	MV		1-Time	
3200	RTTIME	Periodic Rotation Interval	AV	Hours(71)	1 - 999	
3300 through 3355	SCHEDULES00 through SCHEDULES55	Schedules	AV	Minutes(72) since 0:00	0 - 1439, 1440=empty schedule	
3400	SEASON	Season	BV		0=Winter, 1=Summer	
3500	SEQUENCE	Sequence	BV		0=Lo/Hi/Lo/Hi 1=Lo/Lo/Hi/Hi	
3600	SETBACK	Night Setback Temp	AV	psi(56)	-10 - 0psi	
3700	SETPT	Set point	AV	Psi(56)	0 - 30psi	
3800	SHIFT	Day/Night Shift	MV		1=To-Day, 2=To-Night, 3=Extend-Day,	
3900	STBYDLY	Standby Delay	AV	Minutes(72)	1 - 60	
4000	SYSPRES	System Pressure Sensor	AV	psi(56)	-5 - +35	X
4100	SRUNON	System Run-on	AV	Minutes(72)	0 - 60	
4200	SYSTEM	System Relay	BV		0=Off, 1=On	X
4300	THROTTLE	Throttle Range	AV	psi(56)	0.5 - 5	
4400	XYZPRESSURE	Heat Establish Pressure	AV	psi(56)	0.5 - 5	

* AV=analog value(2), BV=binary value(5), MV=multi-state value(19).

Note: The device object id is set through the menus. The device object name is 'HTC_' followed by the panel serial number.

Note: All variables with multiple UOM's depend upon the value of INMODE to determine which one to use.

Note: Use BOOSTADJ, BOOSTMODE, and BOOSTTIME when OPMODE set to 0. Use BOOSTADJ when BOOSTMODE is set to VariDay and VariDayNight. Use BOOSTTIME when BOOSTMODE is set to ManualBoost.

Note: BSTATUS range changes with BTYPE. For example: when BTYPE is set to 0, BSTATUS range 0 to 1; when BTYPE is set to 1, BSTATUS range 0 to 2.

Note: Use DADJUST, FASTCYCLE, NADJUST, and XYZPRESSURE if OPMODE set to 0.

Note: Use SETBACK if OPMODE set to 1

Note: Use LSTHOLD, MINRUN, PURGE, REACT, STBYDLY when LOGIC set to 0.

Note: Use RTTIME when RTMODE set to 0.

Note: Use THROTTLE when LOGIC set to 1.

Note: The MPC has a schedule, which is 7-days, 4 day/night pairs per day. For example: Instance 2000 is the first DAY schedule of Monday; Instance 2001 is the first NIGHT schedule of Monday; Instance 2008 is the first DAY schedule of Tuesday; Instance 2009 is the first NIGHT schedule of Tuesday and so on.

Note: Use the MPCQ installation menu for supplementary information.

Boiler Type Variable Table

BTYPE	LEAD – Special value (Up to NBOILER –1)
0	1 – 32 → 'A' 'B' 'C' ... 'X' 'Y' 'Z' 'a' 'b' 'c' 'd' 'e' 'f'
1	1 – 16 → 'AB' 'CD' 'EF' ... 'WX' 'YZ' 'ab' 'cd' 'ef'
2	1 – 10 → 'ABC' 'DEF' 'GHI' ... 'STU' 'VWX' 'abc' 'def'
3	1 – 8 → 'ABCD' 'EFGH' 'IJKL' 'MNOP' 'QRST' 'UVWX' 'abcd' 'efgh'

Platinum BACnet PICS Statement

Product	Model Number	Protocol Revision	Software Version	Firmware Version
Platinum series BACnet Controls	Varies	1.5	tbd	tbd

Vendor Information

Heat-Timer Corp.
 20 New Dutch Ln. Fairfield, NJ 07004
 (973)575-4004
Vendor ID: 248

Product Description

Various controls for heating or cooling applications. Includes Platinum Models MPC, MPCQ, HWR, HWRQ, Multi-Mod, SRC. (see <http://www.heat-timer.com> for more information)

BACnet Standardized Device Profile (Annex L)

Product	Device Profile
Platinum series BACnet Controls	BACnet Application Specific Controller (B-ASC)

Supported BIBBs (Annex K)

Supported BIBBs	BIBB Name
DS-RP-B	Data Sharing-ReadProperty-B
DS-WP-B	Data Sharing-WriteProperty-B
DM-DDB-B	Device Management-Dynamic Device Binding-B
DM-DOB-B	Device Management-Dynamic Object Binding-B
DM-DCC-B	Device Management-DeviceCommunicationControl-B

Standard Object Types Supported

Object Type	Creatable	Deletable
Analog Value	No	No
Binary Value	No	No
Multi-State Value	No	No
Device	No	No

Data Link Layer Options (Annex J)

Product	Data Link	Options
Platinum series BACnet Controls	BACnet/IP	

Segmentation Capability

Segmentation Type	Supported	Window Size(MS/TP product limited to 1)
Able to transmit segmented messages	No	
Able to receive segmented messages	No	

Device Address Binding

Product	Static Binding Supported
Platinum series BACnet Controls	No

Character Sets

Product	Character Sets supported
Platinum series BACnet Controls	ANSI X3.4

Troubleshooting

Sensor INPUTS

Display shows Sensor OPEN or SHORT

When **OPEN**, Check if the sensor is connected and the wires are continuous to the MPCQ Platinum. Finally, follow the procedure for Display Shows Incorrect Temperature or Pressure. When in **SHORT** Remove the wires from the sensor terminals. The display should change to read **OPEN**. If it does not, the MPCQ Platinum may be damaged.

Display shows an Incorrect Temperature

Remove the wires from the sensor terminals. The display should change to read **OPEN**. If it does not, the MPCQ Platinum may be damaged. Take an ohm reading across the detached sensor wires. The ohm reading should correspond to the Temperature sensor Table. If it does not, the sensor may be damaged.

Display shows an Incorrect Pressure

If the reading is a specified amount above or below the actual pressure adjust it using the System Trim. If the reading is **SHORT**, remove the wires from the sensor terminals. The display should change to read **OPEN**. If it does not, the MPCQ Platinum may be damaged.

CONTROL OPERATION

Too Much Heat

Check if the control has any of the following:

- **Heat Adjustment** - If the overheating occurs only during specific hours, check the Day/Night Schedule (page 26), Day/Night Heat Adjustment (page 21), Day/night Cutoff (page 21), or the Setback settings (page 22).
- **Boiler Mode Settings** - The MPCQ Platinum will only sequence boilers their mode is set to Auto or Standby. Make sure none of the boilers have their Mode set to ON. See page 26.
- **Control Settings** - The Last Stage Hold will allow only the Lead boiler to exceed the set point. If the setting is too high and only the Lead boiler is on, the system can overshoot. Reduce the Last Stage Hold setting. See page 24.

Too Little Heat

Check if the control has any of the following:

- **Setback and Day/Night Schedule** - If reduced heat occurs only during specific hours, check the Day/Night Schedule (page 26), Day/Night Heat Adjustment (page 21), Day/night Cutoff (page 21), or the Setback settings (page 22).
- **Boiler Mode Settings** - The MPCQ Platinum will only control boilers their mode is set to Auto or Standby after a delay. Check if any boilers have their Mode set to Manual, Off, or Standby Delay. See page 26.

Boilers are Short-Cycling

- **Minimum Runtime** - Increase the Minimum Runtime only if all boilers tend to short-cycle. See page 24.
- **Last Stage Hold** - Increase the Last Stage Hold only if the lead boiler tends to short-cycle. See page 24.

System is Overshooting or Oscillating

- **Reaction Time and Minimum Runtime** - If the system is overshooting, increase the Reaction Time (See page 23). This will allow the MPCQ Platinum enough time to respond before bringing on another stage. However, if the system was oscillating, increase the Reaction Time and the Minimum Runtime. See page 24.
- **PID vs OSS** - If the application requires fast response that the normal PID mode cannot provide, try using the OSS mode and adjust the Throttle according to the system requirements. See page 17.

Temperature Sensor Chart

TEMPERATURE (in Degrees °F)	Value (in Ohms)
-30	117720
-20	82823
-10	59076
0	42683
10	31215
20	23089
25	19939
30	17264
35	14985
40	13040
45	11374
50	9944
55	8714
60	7653
70	5941
80	4649
90	3667
100	2914
110	2332
120	1879
130	1524
140	1243
150	1021
160	842
170	699
180	583
190	489
200	412
210	349
220	297
230	253
240	217
250	187

Specifications

Voltage Input:	120 VAC 60 Hz
Power Consumption:	30 VA Max
Operating Temperature:	20°F/-7°C to 120°F/49°C
Operating Humidity:	20% to 80%
Dimensions:	13"W x 13" H x 5 1/2" D
Weight:	14 pounds
Output Relay Ratings:	1 Amp inductive, 6Amp resistive at 120 VAC 60 Hz, 15A total for all circuits
Temperature Display:	Fahrenheit or Celsius.
Display:	80 character Alphanumeric (4 rows with 20 characters each)
LED:	(1) System Output relay (RED LED), (8) Boiler Output relays (RED LED)
Sensor Ranges:	Outdoor temperature sensor - minus 35°F/-37°C to 250°F/ 121°C Pressure Transducer (0 - 30 psi)
Day/Night Outdoor Cutoff Range:	20°F/-7°C to 100°F/38°C
Set Point Pressure Range:	0 - 30 psi
Setback:	Pressure 0.0-10.0 psi
Operating Mode:	Cycle or Set Point
Cycle Length:	10 - 240 minutes
Logic:	PID Logarithm (Cycle or Set Point) or Oversize System (OSS) (Set Point Only)
Boiler Type:	On/Off, 2-Stage, 3-Stage, 4-Stage
Sequencing Mode:	Lo/Hi/Lo/Hi, Lo/Lo/Hi/Hi
Sensor Fault Mode:	Stages On, Stages Off
Day/Night Heat Adjustment:	A (Least Heat) through P (Most Heat)
Reaction Time:	1 to 10 minutes
Minimum Boiler Run Time:	1 to 10 minutes
Stage Operation Modes:	On, Off, Standby, Auto
Standby Time Delay:	0 to 60 minutes
Stage Rotation Modes:	Time (1 to 999 Hours (41 days)), Manual, Last-On
Stage Sequencing:	Lo/Hi/Lo/Hi or Lo/Lo/Hi/Hi
Last-Stage-Hold:	0.0 to 5.0 Psi
Throttle:	0.5 to 5.0 Psi
Purge Delay:	0.0 to 10.0 minutes
System Run-On:	0 to 360 minutes
Schedules:	4 Day Time and 4 Night Time (Setback) settings per day
Morning Boost:	Vari-Boost - Self-adjusting from 0 to 180 minutes Early Shutdown - Self-adjusting from 0 to 90 minutes Manual - Adjustable from 0 to 120 minutes
Power Backup:	Lithium coin battery, 100 days minimum 5 year replacement (Maintains Clock in power outages).
Remote Communication Option:	Internet (RINet) or BACnet IP (BAC)
External Inputs:	1 Network Input, 3 Aux Inputs, Shutdown Input, and Prove Input.
Add-On Extension Panels:	up to two Extension Panels using RS485, Each Panel with 8 stages
Network Input Maximum Sensors:	64 Neuron Sensors including MIG Sensors.
Season:	Winter and Summer.